



MODEL SM-4450 UHF SYNTHESIZED MOBILE

SERVICE MANUAL



Maxon Electronics Australia Pty Ltd
36A Gibson Avenue, Padstow
Sydney NSW 2211 Australia
Tel: +61 2 9707 2000 Fax: +61 2 9707 3328
www.maxon.com.au



SM-4450

SYNTHESIZED MOBILE

SERVICE MANUAL



Maxon Electronics Australia Pty Ltd
36A Gibson Avenue, Padstow
Sydney NSW 2211 Australia
Tel: +61 2 9707 2000 Fax: +61 2 9707 3328

www.maxon.com.au

TABLE OF CONTENTS

GENERAL INFORMATION	3
UNPACKING	3
GENERAL DESCRIPTION	4
PERFORMANCE SPECIFICATIONS	5
GENERAL	5
RECEIVER (PER EIA RS-204-C)	5
TRANSMITTER (PER EIA RS-152-B)	5
DESCRIPTION OF CONTROLS	6
FRONT PANEL CONTROLS	6
BACK PANEL CONNECTORS	7
OPERATION	8
RADIO ON/OFF, POWER UP	8
RECEIVING A CALL	8
TRANSMITTING	8
BLOCK DIAGRAM	9
THEORY OF OPERATION	10
RECEIVER	10
RF Amplifier	10
First Mixer and First IF Amplifier	10
Second Mixer, Second IF, and FM Detector	10
Audio	11
Squelch	11
TRANSMITTER	11
Audio	11
RF Driver and Power Amplifier	11
Automatic Power Control	11
FREQUENCY SYNTHESIZER	12
PLL Integrated Circuit	12
Reference Oscillator	12
Voltage Controlled Oscillator	12
Dual Modulus Prescaler	12
Loop Filter	12
Out-Of-Lock Detector	13
TEST EQUIPMENT	14
PERFORMANCE TESTS	15
TRANSMITTER PERFORMANCE TESTS	15
Power Output	15
Audio Response	15
Limiting Test	15
Spectrum Test	15

May 1992

1

MAXON SM-4450 UHF SYNTHESIZED MOBILE

RECEIVER PERFORMANCE TESTS	16
SINAD Sensitivity	16
Noise Quieting Sensitivity	16
Squelch Sensitivity	16
Audio Output	16
ALIGNMENT INSTRUCTIONS	17
SUGGESTED TEST EQUIPMENT	17
PRE-ALIGNMENT NOTES	17
PLL ALIGNMENT	18
TRANSMITTER ALIGNMENT	19
DCS Modulation Balance Adjustment	19
Modulation Deviation Adjustment	20
RECEIVER ALIGNMENT	21
Receiver Squelch Adjustment	21
PROGRAMMING INSTRUCTIONS	22
PROGRAMMING THE SM-4450	22
While the EEPROM is still in the radio.	22
While the EEPROM is out of the radio.	22
ALIGNMENT POINTS - RF	23
ALIGNMENT POINTS - DIGITAL	24
COMPONENT LAYERS	APPENDIX I
TRANSISTER AND I.C. PIN OUT	APPENDIX II
WIRING DIAGRAMS	APPENDIX III
EXPLODED VIEW	APPENDIX IV
EXPLODED VIEW PARTS LIST	APPENDIX IV
ELECTRICAL PARTS LIST	APPENDIX V
VOLTAGE CHARTS	APPENDIX VI
SCHEMATIC	APPENDIX VI

May 1992

2

GENERAL INFORMATION**UNPACKING**

Check the carton and packing material carefully for the following items:

1. Transceiver Unit
2. Microphone
3. DC Power Cord
4. Mobile Mounting Bracket
5. Assembly Hardware
6. Operating Guide

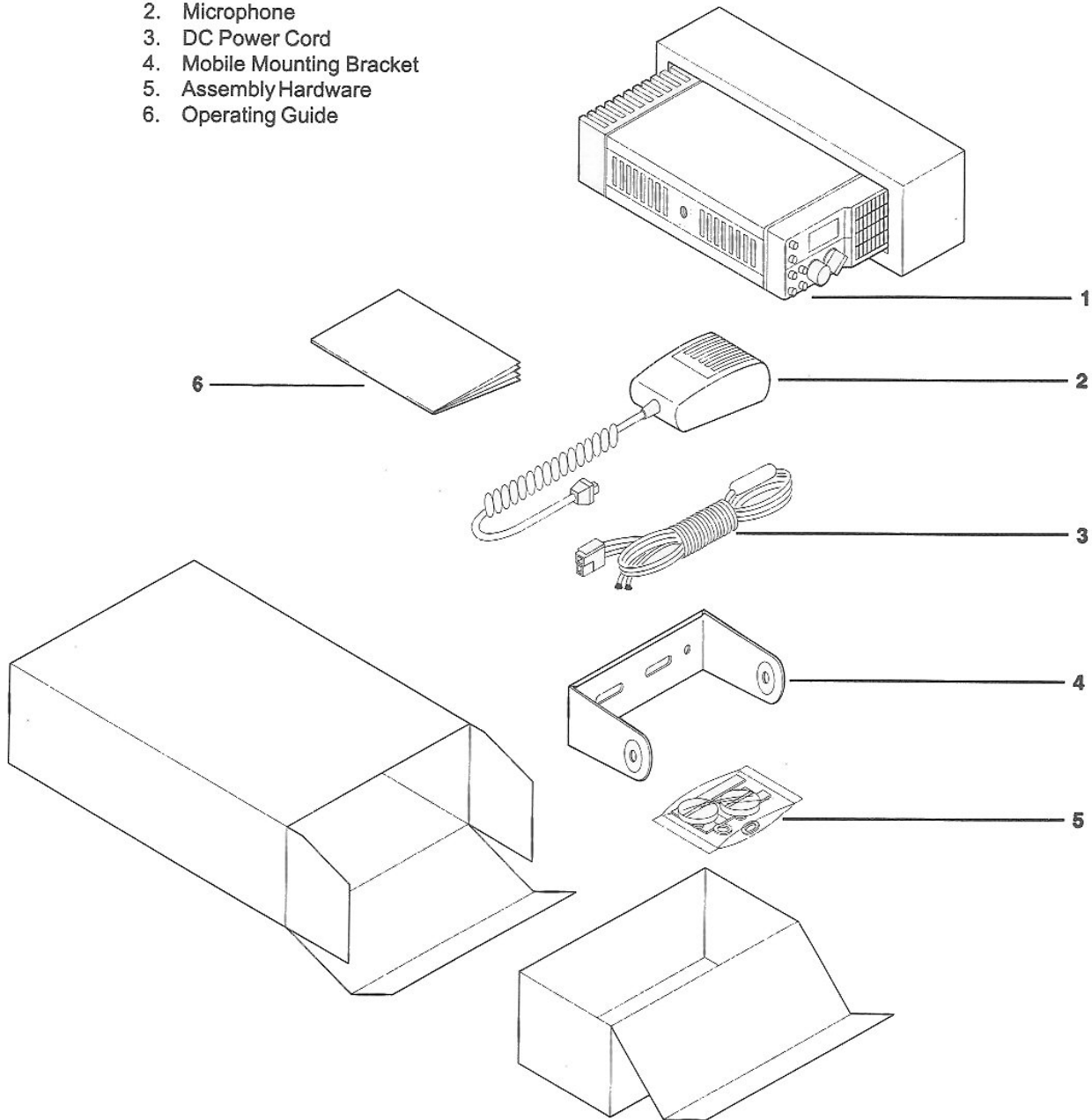

May 1992

3

MAXON SM-4450 UHF SYNTHESIZED MOBILE

GENERAL DESCRIPTION

The SM-4450 mobile radio provides advanced design using state-of-the-art technology. The Phase-Locked-Loop (PLL) synthesizer provides more flexibility and capability in a mobile radio than ever before offered by MAXON.

16 Channel capability, CTCSS and DCS signaling systems compatibility, as well as fast scan function, (including dual level priority scan) are all controlled by the SM-4450's microprocessor. The microprocessor reads specific channel information from an electrically erasable programmable read-only memory (EEPROM).

May 1992

4

MAXON SM-4450 UHF SYNTHESIZED MOBILE

PERFORMANCE SPECIFICATIONS**GENERAL**

Frequency Range	450-470 MHz
Channels	16 Maximum
Channel Spacing	25 Khz Programmable (In 6.25 Khz Steps)
Input Voltage	13.8 VDC Negative Ground
Current Drain	0.15 A Standby 0.5 A Receive 8 A Transmit
Temperature Range	-30° To +60° C
Dimensions (HWD)	2x6x8.25" (51x152x210mm)
Weight	4 lbs., 3oz. (1.9kg) with Mic.
FCC Compliance	Parts 15, 22, 74, 90, 95
FCC ID Designation	F3JSM4450
Standard Signalling Formats	CTCSS, DCS Encode And Decode (selectable by channel)

RECEIVER (PER EIA/TIA-204-D)

RF Input Impedance	50 Ohms nominal
Sensitivity:	
EIA 12 dB SINAD	0.35 μ V
20 dB Quieting	0.50 μ V
Squelch Sensitivity	0.20 μ V Threshold
Selectivity	-80 dB
Intermodulation	-70 dB
Modulation Acceptance Bandwidth	\pm 7.5 kHz
Spurious And Image	\leq 80 dB
Audio Power Output	5w (@ 10% Distortion Into 4 Ohm Load)
Frequency Stability	\pm 0.0005%
Channel Spread	10 MHz (13MHz with 3 dB Degradation)

TRANSMITTER (PER EIA/RS-152-C)

RF Power Output	40 Watts (adjustable)
RF Output Impedance	50 Ohms
Spurious And Harmonics	-70 dBc
Modulation	16KOF3E
FM Hum And Noise	-45 dB Nominal
Audio Distortion	<3% @ 1000 Hz
Frequency Stability	0.0005%
Channel Spread	20 MHz

May 1992

5

DESCRIPTION OF CONTROLS

FRONT PANEL CONTROLS

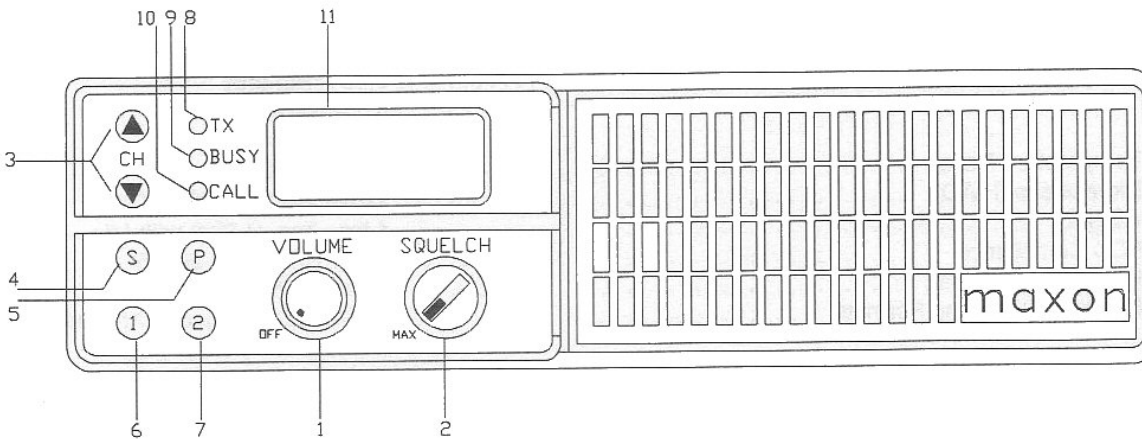

- 1) **ON/OFF/VOLUME CONTROL:** This is the main power switch and volume control.
- 2) **SQUELCH CONTROL:** The squelch control will silence the receiver when no signal is being received.
- 3) **CHANNEL CHANGE BUTTONS (CH):** The channel change buttons allow the operator to scroll either up or down through the programmed channels.
- 4) **SCAN PUSH BUTTON (S):** This button turns the scan function "ON" (indicated by a red backlight) and "OFF". It also serves as the "ENTER" function during scan programming.
- 5) **PRIORITY SCAN PUSH BUTTON (P):** This button turns the priority scan function "ON" (indicated by a red backlight) and "OFF". It also provides access to the programming mode at radio turn on.
- 6) **AUXILIARY SPEAKER BUTTON (1):** This button silences the internal speaker and connects the auxiliary speaker (requires the auxiliary option printed circuit board to be installed). It also deletes channels from the scan list when in the programming mode.
- 7) **MONITOR BUTTON (2):** This button performs three functions:
 1. Disables tone or digital squelch options when in receive mode.
 2. Returns to normal radio operation from the programming mode.
 3. Controls display intensity.
- 8) **TRANSMIT LED INDICATOR (TX):** This red Light Emitting Diode (LED) indicator illuminates during transmit operation. It also will flash to indicate that the synthesizer is out-of-lock.

May 1992

6

MAXON SM-4450 UHF SYNTHESIZED MOBILE

9) **BUSY CHANNEL INDICATOR (BUSY):** This yellow Light Emitting Diode (LED) indicator illuminates to indicate activity on the channel during receive.

10) **CALL LIGHT INDICATOR (CALL):** This green Light Emitting Diode (LED) indicator illuminates to indicate activity on the channel during receive when coded squelch or digital signalling options are used.

11) **CHANNEL DISPLAY:** The front panel display indicates channel number, priority scan numbers, programming mode and error messages.

BACK PANEL CONNECTORS

1) **EXTERNAL SPEAKER CONNECTOR:** This 3.5mm diameter jack is provided for a 4 ohm external speaker. The internal speaker is silenced when an external speaker is connected.

2) **AUXILIARY SPEAKER CONNECTOR:** This 3.5mm diameter jack is provided for an auxiliary speaker.

3) **ANTENNA CONNECTOR:** An SO-239 type connector. The output load must be 50 ohms.

4) **DC 13.8V CONNECTOR:** Polarized plug for 13.8 VDC power input -- FOR NEGATIVE GROUND SYSTEM ONLY.

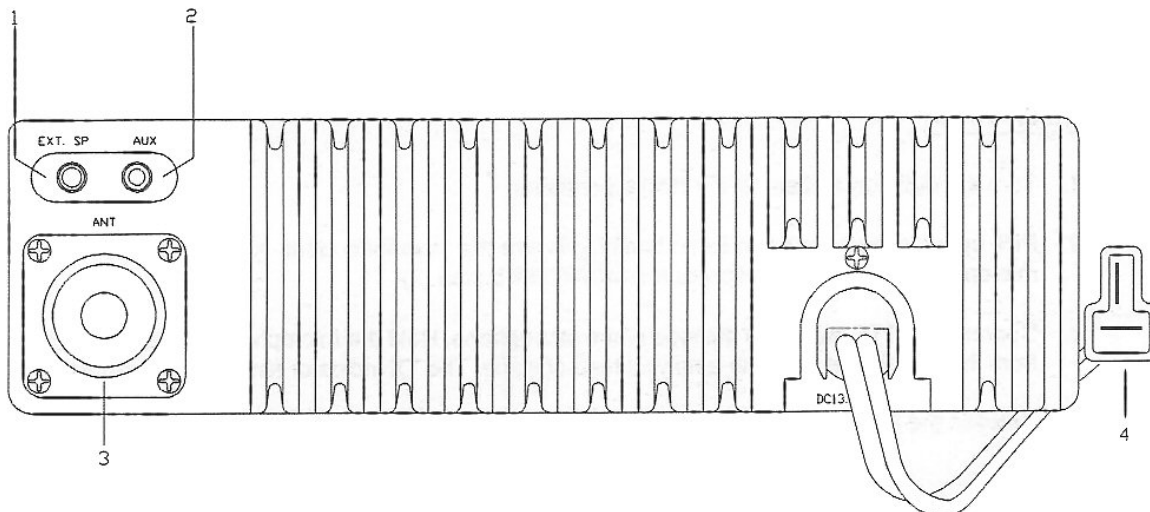

May 1992

7

OPERATION

- **Note: The following description briefly outlines the operation of the SM-4450. Consult the Operators Manual for a complete description of all modes of operation.**

RADIO ON/OFF, POWER UP

1. Turn the radio on by turning the VOLUME control one-half turn clockwise. After "4000" appears in the display and the power up alert tone is generated, the display will change to the #1 priority channel. If no priority channel has been programmed, the display will change to channel 1.
2. Turn the radio off by rotating the VOLUME control fully counter-clockwise.

RECEIVING A CALL

1. Turn the radio on and select the desired channel.
 2. Depress the MONITOR button (2) if necessary to backlight the display. Adjust the volume control to a comfortable listening level.
 3. Rotate the SQUELCH control clockwise until the squelch noise (rushing sound) is no longer present.
 4. Depress the MONITOR button (2) to turn off the backlight.
- **Note: If the radio is equipped with coded squelch options, depress the MONITOR button (2) to enable the option; the CALL indicator will no longer be illuminated.**

TRANSMITTING

1. Turn the radio on and select the desired channel.
2. Pick up the microphone and listen briefly to insure the channel is clear. Alternatively, leave the microphone on-hook and depress the MONITOR button (2).
3. Depress the PTT switch on the side of the microphone. Hold the microphone one to two inches from the mouth and speak in a normal tone of voice. The TX indicator should be illuminated.
4. Release the PTT switch when the message is completed.

May 1992

8

THEORY OF OPERATION

RECEIVER

RF Amplifier

Incoming signals from the antenna jack are routed backwards through the transmitter lowpass filter to PIN diode switch D16. In receive mode, D16 conducts, which allows a low impedance path through the diode to the receiver front end circuitry. The receiver RF amplifier section is comprised of two bandpass filter sections separated by an amplifier based around Q1. These two filters allow signals at or near the operating frequency to pass, but provide strong rejection of the mixer's spurious response frequencies. The first filter section is a two pole design formed around RF transformers T1, T2, and their associated circuitry. This filter is followed by the RF amplifier transistor Q1. This device with its low noise figure, yields good receiver sensitivity while showing strong resistance to overload from strong signals. The output of Q1 drives a pole filter section formed around T2, and T3. The output of the RF amplifier stage is routed to the first mixer.

First Mixer and First IF Amplifier

The action of the first mixer transistor Q2 is to convert incoming signals at the operating frequency to the frequency of the first IF which is 21.4 MHz. The output of the mixer is at a frequency which is equal to the difference between the frequency of the incoming signal and the local oscillator. In this radio, the local oscillator signal is chosen to be 21.4 MHz below the operating frequency. The device chosen to perform the mixing operation is Q2, a high performance JFET. The incoming signal is applied to the gate of Q2 while the local oscillator is applied to the source. The local oscillator signal is filtered by helical resonator T5, and associated circuitry before being supplied to the source of Q2. The difference frequency signal at 21.4 MHz exits the mixer at the drain of Q2 and is tuned for 21.4 MHz, by T4, which drives the first IF filter XF1 and XF2. XF1 and XF2 form a 4-pole monolithic crystal filter pair, this in part determines the selectivity of the radio. The output of the crystal filter is routed to the first IF amplifier formed around Q3. RF transformer T6 provides proper matching of the crystal filters to insure good bandpass response and selectivity.

Second Mixer, Second IF, and FM Detector

The output of Q3 is applied to the input (pin 16) of IC2. IC2 is a single conversion FM receiver on one integrated circuit chip. The signal at the input is routed straight to a mixer which converts the incoming signal to the second IF frequency of 455 kHz. The second local oscillator is formed with crystal X1 and circuitry within IC2. The output of the second mixer is at pin 3 which is connected to a ceramic bandpass filter, CF1, centered at 455 kHz. This filter, along with XF1 and XF2, determine the adjacent channel selectivity of the radio. The output of CF1 drives a high gain IF amplifier chain internal to IC2 which in turn drives the quadrature detector. The output of the detector is amplified and exits IC2 at pin 9.

May 1992

10

Audio

Detected audio from IC2 passes through a lowpass filter formed around L16, C64, and C65 which removes IF frequency components at 455 kHz. The audio signal then passes through buffer amplifier transistor Q7 before being filtered by a two section, 4-pole high pass filter (IC3). This filter removes DCS and CTCSS low frequency tones from the recovered audio. Transistors Q6 and Q108 act as switches around volume control VR2 to mute the audio during squelched receive operation. The audio signal is finally routed to audio power amplifier IC103 and then to the speaker.

Squelch

The presence of an RF carrier is determined by noting the level of ultrasonic noise at the detector output (pin 9) of IC2. When a carrier is present, the noise level drops. The audio at pin 9 of IC2 is filtered by a two-pole bandpass filter formed around L17, L18, C68, and C69. This filter passes audio at and near an audio frequency of 50 kHz. This frequency is high enough that voice audio and its harmonics will not cause improper squelch operation. The output of the filter is routed to an amplifier internal to IC2. The output of the amplifier drives Q4. The DC voltage at the detector output is amplified and filtered by Q4. The output of Q4 sends its squelch signal to the microprocessor. When the microprocessor determines that a valid carrier exists, it sends an unmute signal to the audio switch transistors Q6 and Q108.

TRANSMITTER

Audio

The microphone audio is amplified, pre-emphasized, and peak limited by circuits within IC113. The output of the limiter is routed through RV4, the microphone deviation control. Input CTCSS and routed DCS signals are routed through RV5, the CTCSS/DCS deviation control. Both signals are summed through a lowpass filter formed around IC114 to remove high frequency components from the limiter which could cause channel splatter. When the microprocessor enables the TX 8 Volt supply, analog gate IC115 delivers the modulation signal to the VCO transistor Q115 by changing the capacitance of D123 and D124.

RF Driver and Power Amplifier

Diode D10 acts as a switch allowing the RF signal from the phase-locked-loop frequency synthesizer to pass through to the RF driver and power amplifier during transmit, but not during receive. Buffer amplifier Q10 amplifies the carrier to the level needed by the driver amplifier stages. The driver amplifiers, of which the last 2 stages are gain controlled by the automatic power control, drive the final amplifier stage formed around Q14. The final amplifier boosts the carrier level to the power level set by the automatic power control. The carrier signal passes through the automatic power control directional coupler, the RF output lowpass filter, and then is routed to the antenna connector.

Automatic Power Control

The automatic power control directional coupler samples a portion of the forward RF power output to determine the RF level. Diode D15 rectifies this RF sample and produces a DC voltage which is proportional to the RF output level. This DC signal is summed with the voltage set from the power output control RV3. This voltage is compared with a voltage derived from the TX 8 Volt supply and the difference is amplified by IC5. The output of the RF driver is proportional to its supply voltage.

MAXON SM-4450 UHF SYNTHESIZED MOBILE

This completes a negative feedback loop which results in constant output power over supply voltage and temperature variations. This controls the DC output of Q9, which supplies Q12 and Q13 controlling the output of Q14 over the range from 10 to 40 watts.

FREQUENCY SYNTHESIZER

The phase-locked-loop (PLL) frequency synthesizer section is responsible for generating the RF signal at the carrier frequency during transmit and at the local oscillator frequency during receive. The PLL functions by comparing the output frequency of a voltage controlled oscillator (VCO) with a fixed frequency reference. An error signal is generated which drives the control input of the voltage controlled oscillator to force its frequency to match the reference. The PLL based frequency synthesizer has a digital frequency divider inserted between the output of the VCO and the frequency comparison circuitry. As this divider number is varied, the output frequency of the VCO varies as well with a frequency step size equal to the reference frequency (6.25 kHz in this radio). This allows a large range of frequencies to be generated with one well-controlled oscillator signal, the reference.

PLL Integrated Circuit

IC118 contains most of the digital circuitry to form a PLL frequency synthesizer. This includes a reference oscillator, programmable reference frequency divider, a programmable variable frequency divider, a modulus control counter, a phase/frequency comparator, and a frequency lock detector. The operation of this integrated circuit is controlled by the radio's microprocessor through a serial data line.

Reference Oscillator

Crystal X2, varactor diode D122, a thermistor/resistor network, and the oscillator stage of IC118 form a temperature compensated 12.8 MHz oscillator. This frequency is divided by 2048 to generate the 6.25 kHz reference frequency for the PLL frequency synthesizer. This reference determines the frequency stability of the overall radio.

Voltage Controlled Oscillator

Transistor Q115 and its associated circuitry form a voltage controlled oscillator which is voltage tuned by varactor diodes D123 and D124 and bandswitched by D123 and D124. The VCO output is buffered and isolated by Q117, Q118, and Q119. Audio modulation is applied to the anodes of D123 and D124 to produce frequency modulation during transmit.

Dual Modulus Prescaler

The internal dividers within IC118 are not able to operate at the VCO output frequency. To alleviate this problem, part of the overall frequency division necessary between the VCO and the phase/frequency comparator is placed external to, and controlled by, IC118. IC117 divides the VCO frequency by 64 or 65, determined by the state of IC118, pin 6. This produces a lower frequency which can be further divided by IC118. By strategic timing when to divide by 128 or 129, the overall division will be that necessary to put the VCO on the correct frequency.

Loop Filter

Resistors R317, R318, R319, R322 and capacitors C291, C294, and C295 form the loop filter. The purpose of the loop filter is to filter out the 6.25 kHz reference frequency products from IC118 phase/frequency comparator output and to determine the dynamic operation of the overall loop.

May 1992

12

R316, C289, Q113, and Q114 act to speed up operation of the synthesizer loop during channel changes and during receive to transmit and transmit to receive frequency changes.

Out-Of-Lock Detector

IC108 contains a circuit which compares the timing difference of the 6.25 kHz reference frequency and the divided down VCO frequency. The output is a 6.25 kHz pulse whose duration is equal to the timing difference. R306 filters the pulse and averages it producing a DC voltage which is proportional to the pulse width. When the loop is in lock, this voltage is zero, but when the loop is out of lock, it rises to a level which will forward bias Q112. The output of Q112 drives the microprocessor. The microprocessor will not allow the radio to transmit unless the synthesizer is in lock. This is to prevent out of band signals from being transmitted.

May 1992

13

MAXON SM-4450 UHF SYNTHESIZED MOBILE

TEST EQUIPMENT

TRANSMITTER

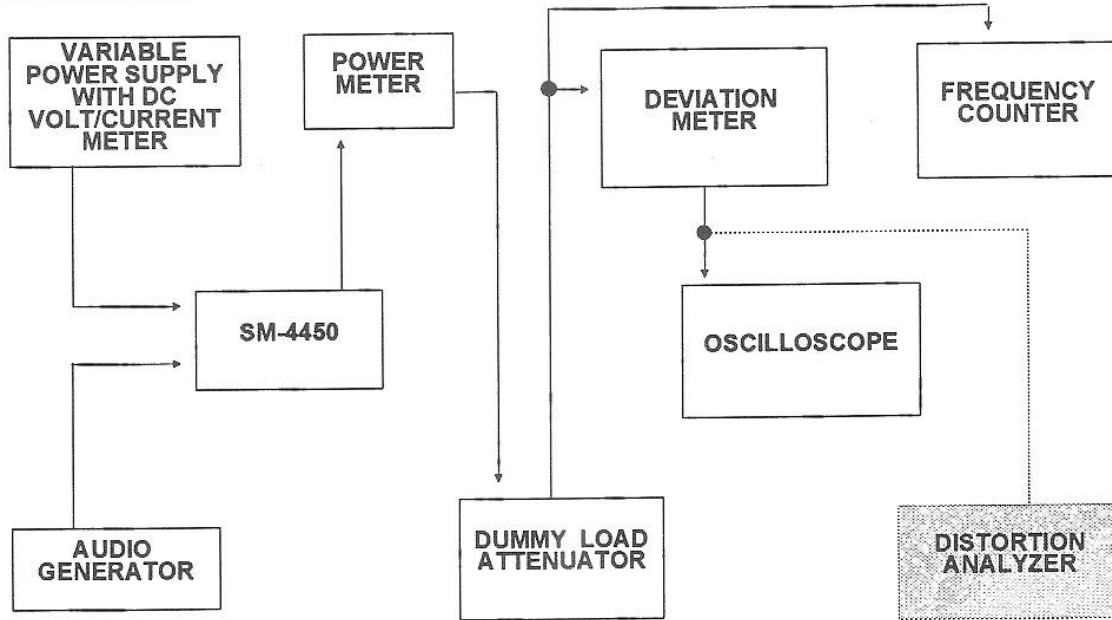

RECEIVER

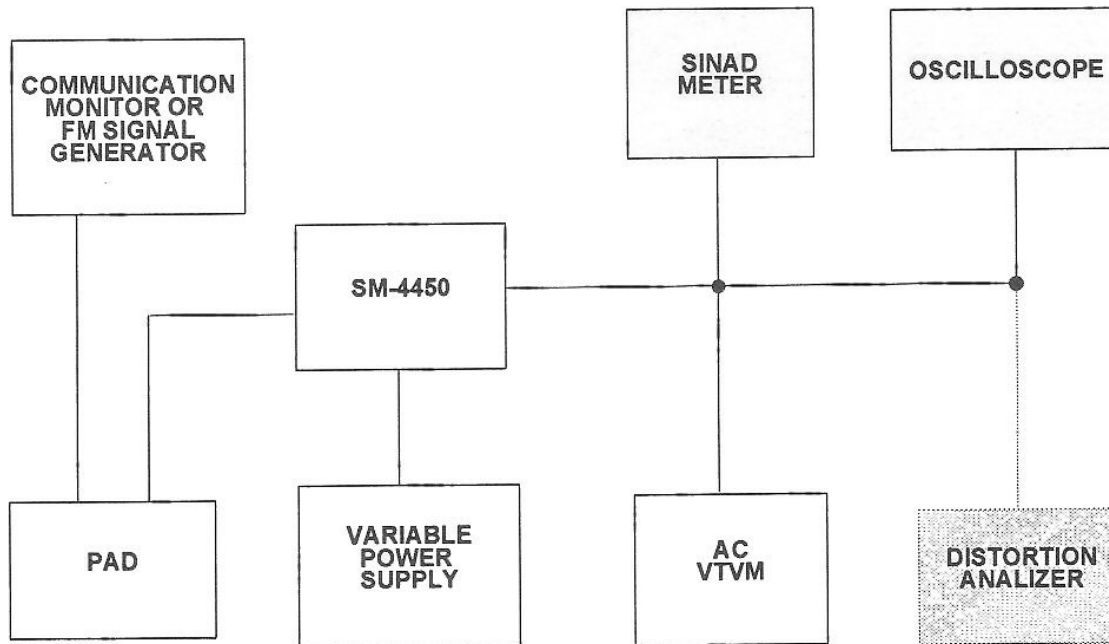

INDICATES OPTIONAL TEST EQUIPMENT

May 1992
14

PERFORMANCE TESTS

TRANSMITTER PERFORMANCE TESTS

Power Output

- A. Set the Power Supply voltage to 13.8 VDC (measured at the radio during transmit).
- B. Connect an RF Wattmeter and dummy load to the antenna receptacle.
- C. Press the PTT switch.
- D. Verify that the output is at least 40 watts.
- E. Reduce the Power Supply voltage to 11 VDC.
- F. Verify that the output is at least 15 watts.
- G. Release the PTT switch.

Audio Response

- A. Connect an Audio Generator to the microphone jack on the radio. Set the generator for a frequency of 1 kHz.
- B. Connect a Communication Service Monitor to the RF output of the radio through a power attenuator. Set the monitor to read average peak FM deviation.
- C. Press the PTT switch.
- D. Adjust the Audio Generator level to produce 1 kHz deviation.
- E. Set the Audio Generator frequency to 2 kHz. The transmitter deviation should be approximately 2 kHz.
- F. As the Audio Generator frequency is varied from 300 Hz to 10 kHz, the deviation should increase until it reaches a maximum at an audio frequency of 2.5 kHz to 2.9 kHz. At higher frequencies, the deviation should decrease. The deviation at an audio frequency of 6 kHz should be less than 1 kHz.
- G. Release the PTT switch.

Limiting Test

- A. Set the Audio Generator frequency to 1 kHz.
- B. Press the PTT switch and adjust the generator level to produce 1 kHz deviation. Note the generator level.
- C. Increase the Audio Generator level by 20 dB (factor of 10 times).
- D. Sweep the Audio Generator over a frequency range of 300 Hz to 3 kHz. The deviation should not exceed ± 5 kHz within this range.
- E. Release the PTT switch.

Spectrum Test

- A. Connect a Spectrum Analyzer to a sampled RF output of the radio.
- B. Press the PTT switch. Observe the output spectrum on the Spectrum Analyzer.
- C. All spurious and harmonics should be at least 60 dB below the carrier level.
- D. Release the PTT switch.

RECEIVER PERFORMANCE TESTS

SINAD Sensitivity

- A. Connect the FM Signal Generator or Communication Service Monitor to the antenna jack.
- B. Connect a SINAD Meter across the speaker leads.
- C. Turn the SQUELCH control fully counterclockwise for maximum noise.
- D. Adjust the VOLUME control to approximately mid-range.
- E. Set the FM signal Generator/Service Monitor to the receive frequency. The modulation should be set for 3 kHz deviation of a 1 kHz tone.
- F. Adjust the generator RF level so that the SINAD Meter reads 12 dB. The signal Generator RF level should be .35 uV or less.

Noise Quieting Sensitivity

- A. Connect a VOM to the speaker leads.
- B. Turn the SQUELCH control fully counterclockwise for maximum noise.
- C. With no RF Signal Generator or Communication Service Monitor connected to the radio, adjust the VOLUME control to obtain a noise reading of 1 volt RMS on the VOM.
- D. Connect the RF Signal Generator/Service Monitor to the radio. Set the RF frequency to the receiver frequency of the radio and remove any modulation.
- E. Adjust the Signal Generator RF level for a noise reading on the VOM of 0.1 volt RMS. This is the 20 dB noise quieting point. The RF level should be 0.5 uV or less.

Squelch Sensitivity

- A. Set the RF Signal Generator/Service Monitor to the receive frequency. Set the modulation to 3 kHz deviation of a 1 kHz audio tone.
- B. Reduce the Signal Generator RF output to zero.
- C. Rotate the SQUELCH control clockwise to the point where the speaker noise just goes away.
- D. Increase the Signal Generator/Service Monitor RF level until the speaker noise returns. This is the threshold squelch setting. The generator output level should not exceed 0.20 uV.
- E. Turn the SQUELCH control to maximum clockwise rotation.
- F. Increase the generator output level until the squelch opens (busy LED is on). The output level should be between 10 and 20 dB (3 to 10 times) above the threshold setting.

Audio Output

- A. Increase the RF Signal Generator/Service Monitor RF level to 1000 uV.
- B. Connect a 4 ohm audio dummy load to the AUXILIARY speaker jack.
- C. Connect a true RMS Audio Voltmeter (the Audio Distortion Analyzer may include this function) to the speaker leads.
- D. With a 3 kHz deviation of a 1 kHz tone modulation applied to the Signal Generator, rotate the VOLUME control clockwise until the audio distortion is 10% or until the VOLUME control reaches stop, whichever comes first.
- E. The Audio Voltmeter should read 4.0 volts or greater.

ALIGNMENT INSTRUCTIONS

WARNING!!!

Any repairs or adjustments should be made under the supervision of a qualified radio telephone technician.

SUGGESTED TEST EQUIPMENT

The following equipment, or its equivalent, is required for proper alignment of the SM-4450:

1. Termline Wattmeter or Through-line Wattmeter with termination into 50 ohm dummy load.
2. AC/DC VOM with a minimum of 1 Megohm input impedance.
3. SINAD Meter.
4. FM Communications Monitor.
5. Regulated Power Supply capable of 9 volts to 16 volts adjustable; at least 10 ampere capability.
6. Oscilloscope.
7. Audio Distortion Meter (desirable but not necessary).
8. Frequency Counter.

PRE-ALIGNMENT NOTES

1. Refer to the Alignment Points Drawings as required for location of components.
2. The SM-4450-SC covers the entire 450-470 MHz frequency range without component changes.
3. The radio has been factory aligned so that its receiver will operate from 460 MHz to 470 MHz. The transmitter will operate between 450 MHz and 470 MHz. If operation is to be within this range, no further alignment is necessary. If operation outside this range (but still within the appropriate frequency band) is desired, the following alignment procedure should be performed.
4. The operating bandwidth range of the receiver in this radio is typically 10MHz for receiver frequencies. A receiver frequency more than 10MHz up from the lowest receiver frequency may be programmed and used. The receiver should be aligned at a frequency in the center of the highest and lowest receive frequencies to be used. There may be some degradation (between 3 and 6 dB at extreme edges) in actual receiver performance if a bandwidth of more than 10 MHz is used.
5. The highest transmit frequency can typically be only 10 MHz above the lowest receiver frequency. Any transmit frequency between 450 MHz and 470 MHz can be programmed and used if the voltage measurement in step 6 in the following procedure is as stated.

May 1992

17

MAXON SM-4450 UHF SYNTHESIZED MOBILE

PLL ALIGNMENT

1. Connect an RF dummy load or power attenuator (50 watt minimum rating) to the antenna receptacle.
2. Connect a VOM or DVM to TP1, accessed through a hole in the VCO cover.
3. Set the CHANNEL selector to the lowest receive frequency.
4. Adjust TC13 setting the voltage measured at TP1 to 1.5 volts ($\pm .05$).
 - **NOTE: Adjustment may require a special tool or care must be taken to insure tool properly mates with component adjustment slots. OUTER RING ROTATES.**
5. Change the CHANNEL selector to the highest transmit frequency.
6. Press the PTT switch. The VOM should read less than 7.5 volts.
7. Release the PTT switch.

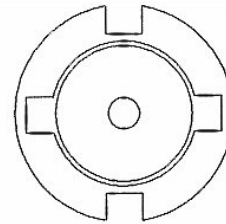

May 1992

18

TRANSMITTER ALIGNMENT

- A. Connect a 50 ohm RF dummy load or a Power Attenuator (50 watt minimum rating) through a wattmeter (50 watt scale) to the antenna receptacle.
- B. Turn VR3 (Automatic Power Adjustment) fully clockwise.
- C. Connect variable DC Power Supply (10 Ampere capability) to the DC power cable on the radio. Set the voltage to 13.8VDC measured at the radio during transmit. (Voltage drops in the power cable during transmit will lower the voltage at the radio).
- D. Set the CHANNEL selector to a mid-frequency transmit channel.
- E. Press the PTT switch. NOTE: The power output may exceed 50 watts.
- F. Adjust VR3 for 40 watts, or the desired power output. (10 - 40 watts). Release the PTT switch.
 - **WARNING!!!**
To prevent damage to the radio, avoid key down periods longer than 1 minute. Allow a 5 minute cool down period after any continuous key down period of 1 minute.
- G. Check the power output at the lowest, middle, and highest transmit channels and adjust VR3, if necessary, to maintain 40 watts at all frequencies.
- H. Press PTT and adjust TC11 for the correct frequency.

DCS Modulation Balance Adjustment

- A. Connect test equipment to the radio as shown on Test Equipment Drawing.
 - **WARNING!!!**
The power attenuator must have enough attenuation to prevent damage to the Deviation Meter.
- B. Set the CHANNEL selector to a transmit channel which has a DCS code pre-programmed (should be mid-frequency channel).
- C. Press the PTT switch.
- D. Observe the waveform on the Oscilloscope and compare with that shown below.

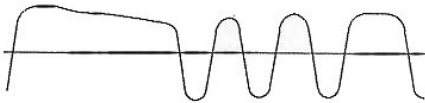

CORRECT ADJUSTMENT

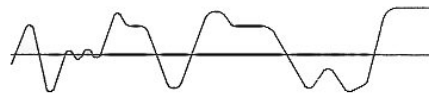

INCORRECT ADJUSTMENT

- E. Adjust RV5 and TC12 to achieve the proper waveform. Release the PTT switch.

MAXON SM-4450 UHF SYNTHESIZED MOBILE

- **NOTE: TC12 should not be allowed to be placed at the maximum capacitance position, as shown below. If TC12 should be found to be at the maximum capacitance position, place TC12 at the typical position and adjust RV5 for the proper waveform.**



MAXIMUM CAPACITANCE POSITION



TYPICAL POSITION

- Replace the Deviation Meter with a Frequency Counter.
- Set the CHANNEL selector to the highest transmit channel. Ensure that this channel has no DCS or CTCSS tones pre-programmed.
- Press the PTT switch. Adjust TC11 for the correct transmit frequency. Release the PTT.

Modulation Deviation Adjustment

- Connect an RF Deviation Meter to the radio through a Power Attenuator.
- Set the CHANNEL selector to a transmit channel which has a DCS code pre-programmed (should be a mid-frequency channel).
- Press the PTT switch.
- Adjust RV3 for proper deviation, typically 750 Hz. Release the PTT switch.
- Set the CHANNEL selector to a transmit channel which has a low-frequency CTCSS tone (67.0Hz) pre-programmed.
- Press the PTT switch and verify that the deviation is between 500 Hz and 1000 Hz. Release the PTT switch.
- Set the CHANNEL selector to a transmit channel which has a high-frequency CTCSS tone (250.3 Hz.) preprogrammed.
- Press the PTT switch and verify that the deviation is between 500 Hz and 1000 Hz. Release the PTT switch.
- Connect an Audio Frequency Generator to the MIC input (connected to the white wire in the microphone cable) of the radio. Set the audio output level for 30 mV. The audio frequency should be 1 kHz.
- Press the PTT switch.
- Adjust RV4 (Maximum Deviation Adjustment) for the 4.2 kHz deviation if no CTCSS tones are present, and 4.9 kHz deviation if CTCSS tones are present.

May 1992

20

MAXON SM-4450 UHF SYNTHESIZED MOBILE

RECEIVER ALIGNMENT

- A. Connect an RF Signal Generator or Communications Service Monitor to the antenna receptacle.
- B. Connect a SINAD Meter and an Audio Distortion Analyzer across the speaker terminals. If an Audio Distortion Analyzer is not available, connect an Oscilloscope across the speaker terminals.
- C. Turn the SQUELCH control fully counter-clockwise.
- D. Adjust the VOLUME control to the proper level for the SINAD Meter and Audio Distortion Analyzer.
- E. Set the CHANNEL selector to a mid-frequency receive channel.
- F. Tune the RF Signal Generator to the channel frequency. The RF output level should be set for -47dBm. The modulation should be set for ± 3 kHz FM deviation of a 1 kHz tone.
- G. Adjust T7 for maximum audio output. Readjust the VOLUME control if necessary to avoid clipping on the output audio waveform. (This adjustment is typically not required.)
- H. Decrease the RF generator output and adjust T1 through T5 for maximum sensitivity.
 - **NOTE: During this adjustment the Signal Generator level should be reduced periodically to keep the SINAD meter reading near 12 dB.**
- I. Check the sensitivity at the lowest and highest receive frequencies. If necessary, repeat steps H. and I. at the lowest, middle and highest frequencies for the best overall sensitivity.

Receiver Squelch Adjustment

- A. Set the channel selector for the mid-frequency receive channel.
- B. Connect an RF Signal Generator or Communications Service Monitor to the Antenna receptacle. The modulation should be set for ± 3 kHz FM modulation of a 1 kHz tone. The RF output level should be at a minimum.
- C. Adjust the SQUELCH control to the threshold point i.e. the point where the speaker audio disappears.
- D. Increase the RF Signal Generator output level until speaker audio output reappears. Note the generator level.
- E. Turn the SQUELCH control fully clockwise.
- F. Increase the RF Signal Generator level by 16 dB.
 - **NOTE: This squelch adjustment procedure is very important for the correct operation of the microprocessor aided squelch system.**

May 1992

21

PROGRAMMING INSTRUCTIONS

PROGRAMMING THE SM-4450

- To program the SM-4450 radio you must use the SMP-4000 Programmer.

There are two ways to program the EEPROM:

1. While the EEPROM is still in the radio.

The SMP-4000 programmer comes with a programming cable, one end has a 16 pin connector and the other end has a 6 pin connector that fits into the connector PL1 on the digital board inside the radio. To use this cable, remove the top cover of the radio. Plug the six pin connector into the socket inside the radio (PL1), which is located near the EEPROM IC107. Plug the other end into the SMP-4000 programming socket as shown in the SMP-4000 Programming Manual. In order to program the radio with the programming cable, it is necessary to put the radio into the programming mode (press the P "PRIORITY" button on the radio). The radio will sound a prompt tone and show the words "PROG" on the display. Please refer to the SMP-4000 Manual for further instructions and for the SM-4000 Series Programming Menu Tree. After completing the programming instructions in the SMP-4000 Manual, remove the cable from PL1 and replace the cover on the SM-4450.

2. While the EEPROM is out of the radio.

To program the SM-4450 EEPROM while out of the radio, the EEPROM must be first removed from the radio and placed in the Textool 16 pin connector on the top panel of the SMP-4000 Programmer.

- Take note as to the location of the notch on the top of the EEPROM and make sure after completing the programming procedure that it is replaced exactly as it was removed.

Make sure the Textool 16 pin connector is unlocked or in the up position. Place the EEPROM in the lower half of the Textool with the notch nearest the display of the SMP-4000. Lock the EEPROM in the Textool by pushing the lever to the down position closest the SMP-4000 display. Leave the EEPROM in the locked position while performing the remainder of the programming instructions outlined in the SMP-4000 Manual. When the programming is complete, unlock the Textool by raising the lever, remove the EEPROM from the programmer and replace it in the DIP socket in the radio's digital board.

- Make sure that the notch is in the same location as when it was removed from the radio.

May 1992

22

ALIGNMENT POINTS

RF MAIN ALIGNMENT

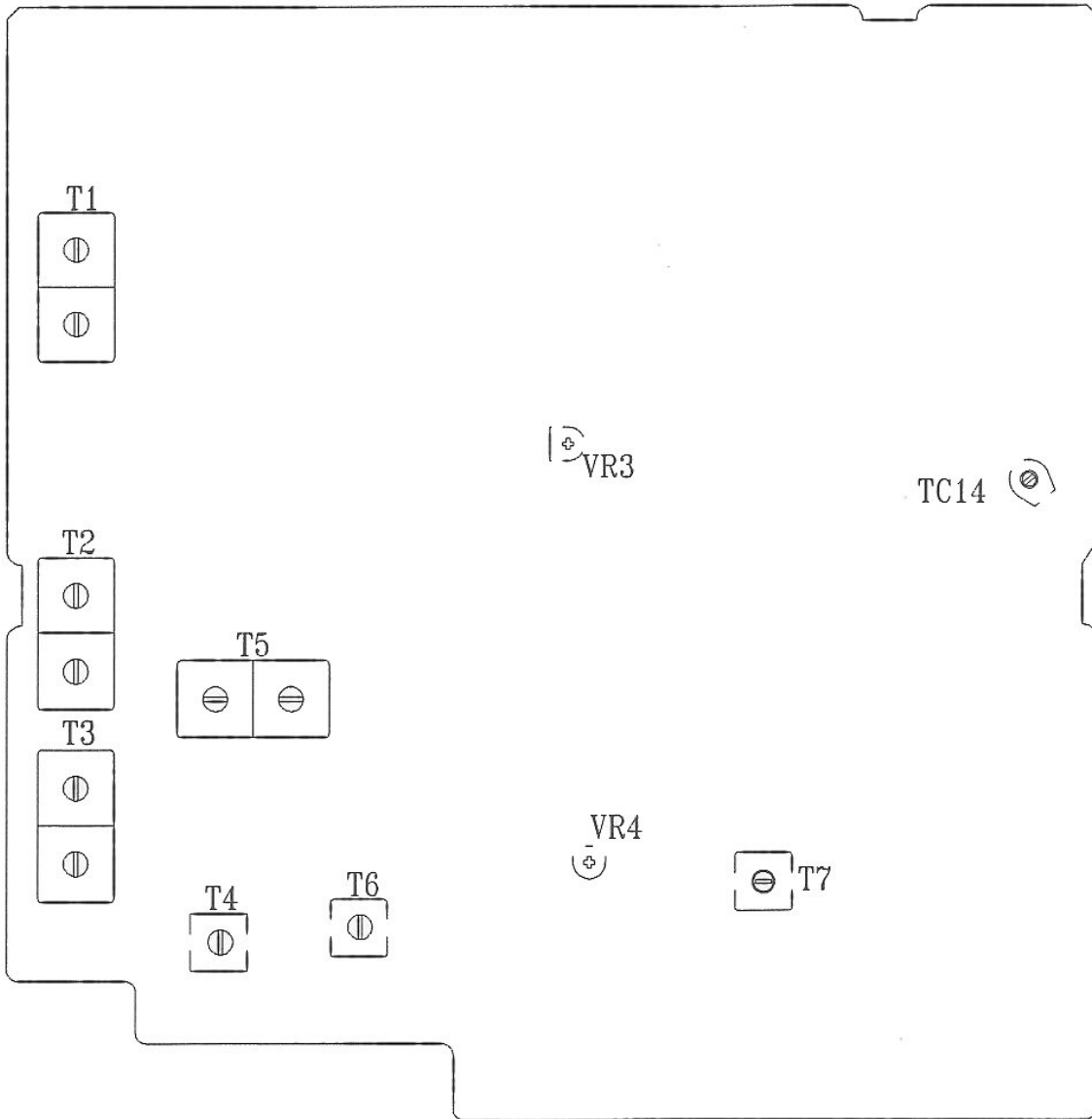

May 1992
23

ALIGNMENT POINTS

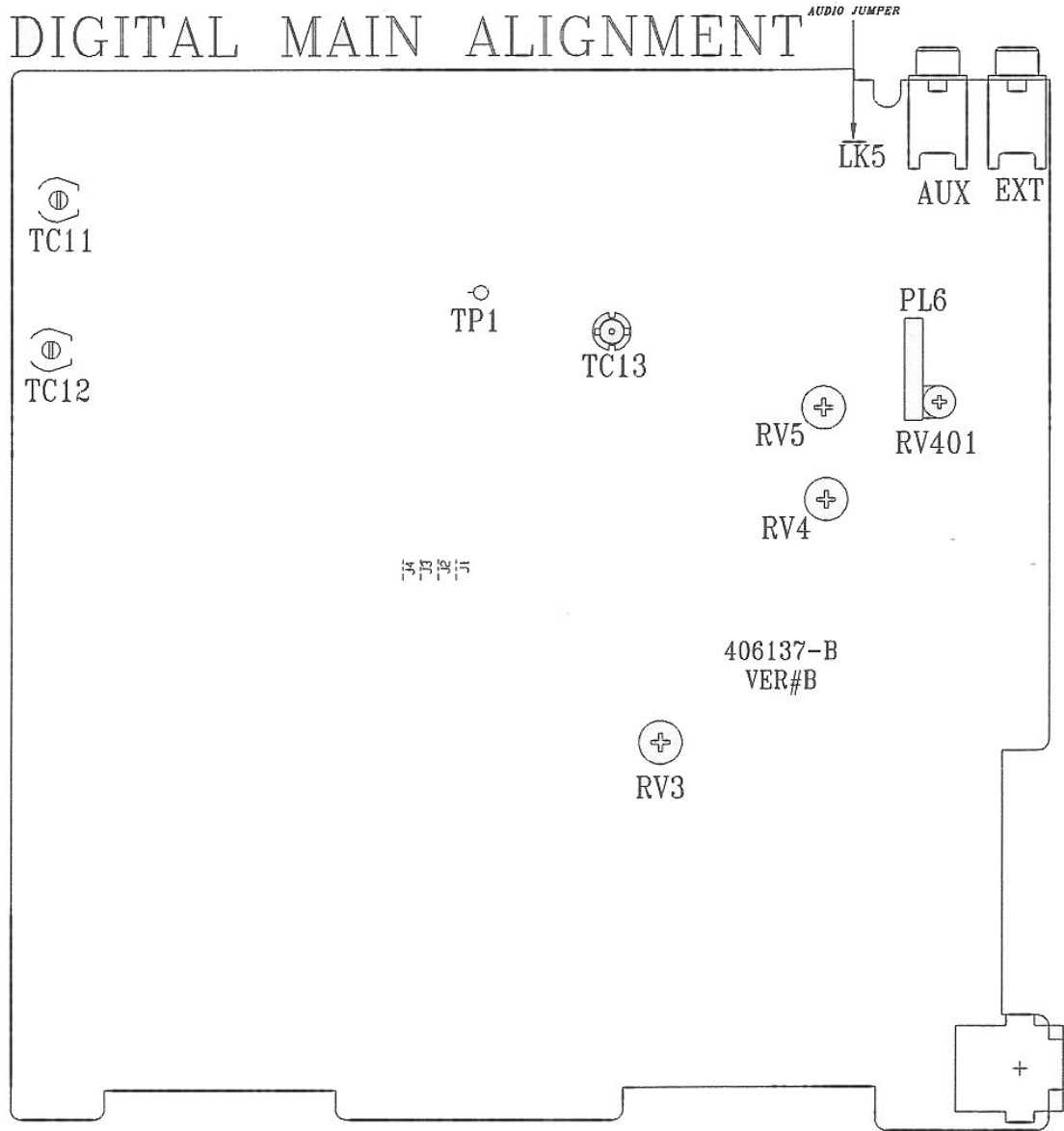

May 1992
24

APPENDIX I

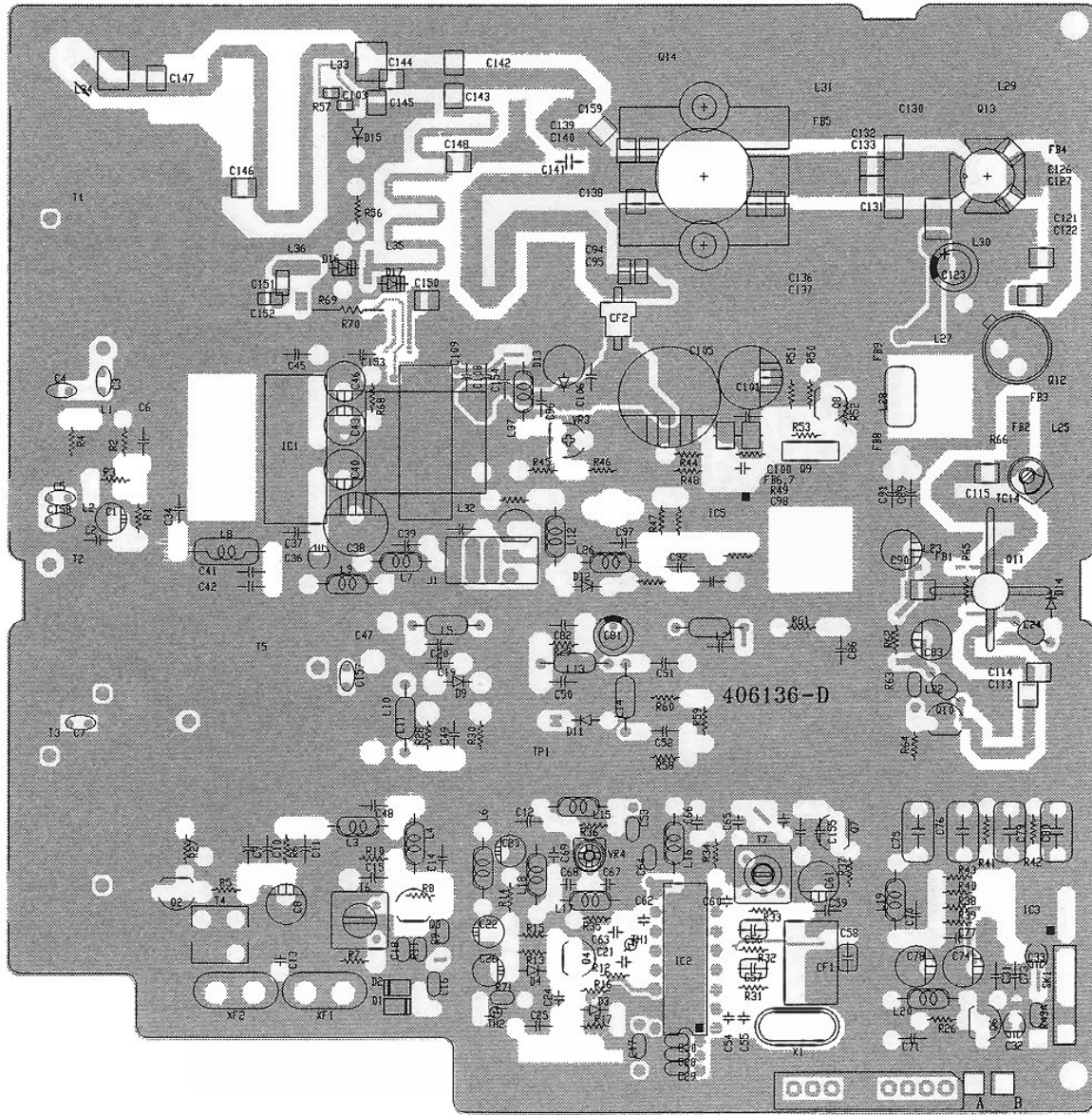

RF PCB (TOP)

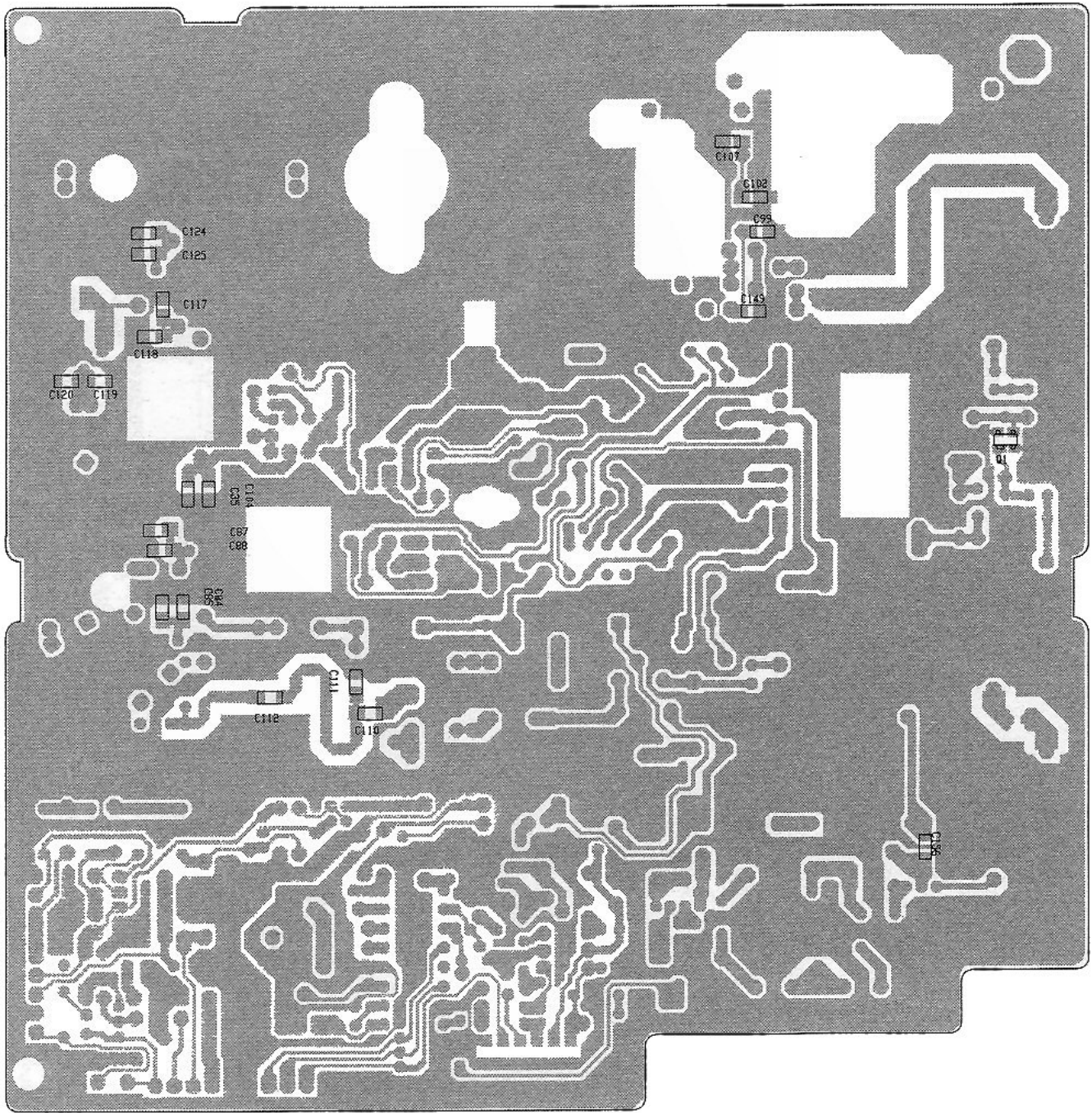

RF PCB (BOTTOM)



APPENDIX II



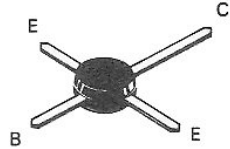
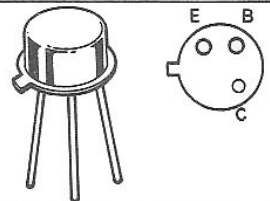
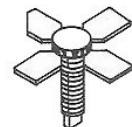
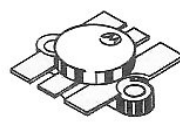
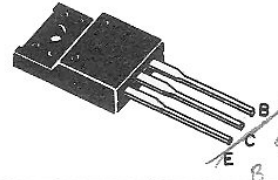
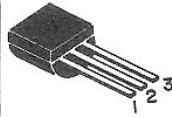
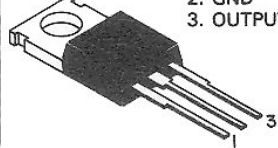

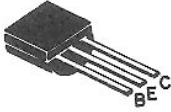
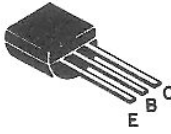
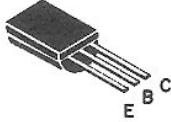
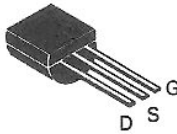
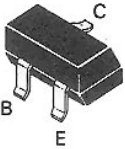
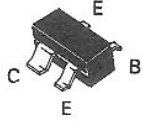
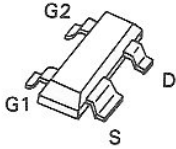
MAXON SM-4450 VHF SYNTHESIZED MOBILE

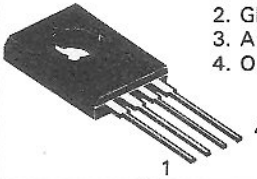
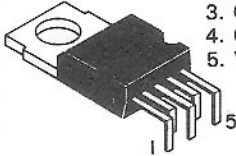
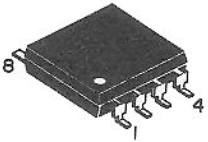
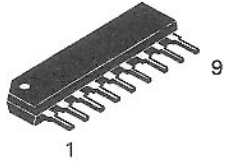
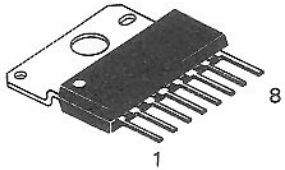
Transistor & IC Pinout Information

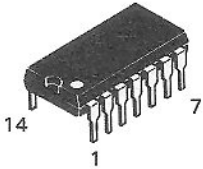
SCHEMATIC REFERENCE NO.	MAXON PART NUMBER	MANUFACTURER'S PART NUMBER	BASE DIAGRAM
Q11	203-055-7	MRF581	
Q12	203-066-7	MRF630	
Q13	203-067-8	MRF654	
Q14*	208-007-9	SD1434 MRF650	
Q9	202-066-2 <i>202-1252</i>	KTB1367 <i>KTA 1658</i>	
IC116	223-119-8	78L05	 <ul style="list-style-type: none"> 1. OUTPUT 2. GND 3. INPUT
IC101	223-001-4	MC7805CT	 <ul style="list-style-type: none"> 1. INPUT 2. GND 3. OUTPUT

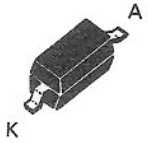
SCHEMATIC REFERENCE NO.	MAXON PART NUMBER	MANUFACTURER'S PART NUMBER	BASE DIAGRAM
Q3 Q10	203-005-2 203-040-3	MPS9426(C) LP1001	
Q104, Q105 Q8, Q102, Q103 Q1, Q4, Q101, Q106 Q107 Q5, Q6, Q7, Q108, Q109, Q110	203-115-8 203-010-6 203-009-6 203-014-0	2N2222 MPS9418 (T) MPS9681 (T) MPS9631 (T)	
Q2*	203-054-6	LSP966	
	203-086-5	J310	
Q114 Q117, Q119 Q111, Q112, Q113, Q116	203-156-5 200-003-5 203-158-7	BC858L BFR92A BC848BL	
Q1 Q115	203-145-5 203-104-8	MRF9511 MRF5711	
Q118	213-006-1	BF998	

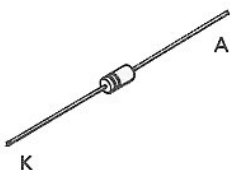
SCHEMATIC REFERENCE NO.	MAXON PART NUMBER	MANUFACTURER'S PART NUMBER	BASE DIAGRAM
IC102	225-004-7	AN6540	 <ul style="list-style-type: none"> 1. +INPUT 2. GND 3. ADJ 4. OUTPUT
IC103	229-075-1	TDA-2003H	 <ul style="list-style-type: none"> 1. +INPUT 2. -INPUT 3. GND 4. OUTPUT 5. Vcc
IC117 IC4, 201	229-217-3 223-124-2	MB501LPF LM358D SO-8	
IC110, IC112	224-022-8	LA6458S	
IC1	229-074-0	MB3756	
IC108* IC113, IC114 IC2, IC5, IC111	229-463-8 231-046-8 224-032-7 231-013-8	CAT93C56HP NMC9346 LA6458D LM358N	
IC115	223-080-5	MC14066B	

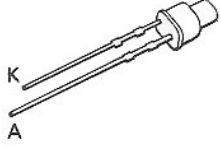
SCHEMATIC REFERENCE NO.	MAXON PART NUMBER	MANUFACTURER'S PART NUMBER	BASE DIAGRAM
D123, D124	249-051-5	BB515-E7906	
D122	243-037-3	BB609A	
D16, D17	243-016-4	UM9401	
D15	243-026-3	SCHOTT1SS97	
D101, D102 D13 * D104	245-013-1 245-008-7 245-024-1	1N4001 2A100V 1N5819	
D106 D107 D109	251-042-0 251-041-9 251-069-5	SLC22GG3 SLC22UR3 SLC22YY3 (YEL)	

APPENDIX III

SM-4450 WIRING DIAGRAM

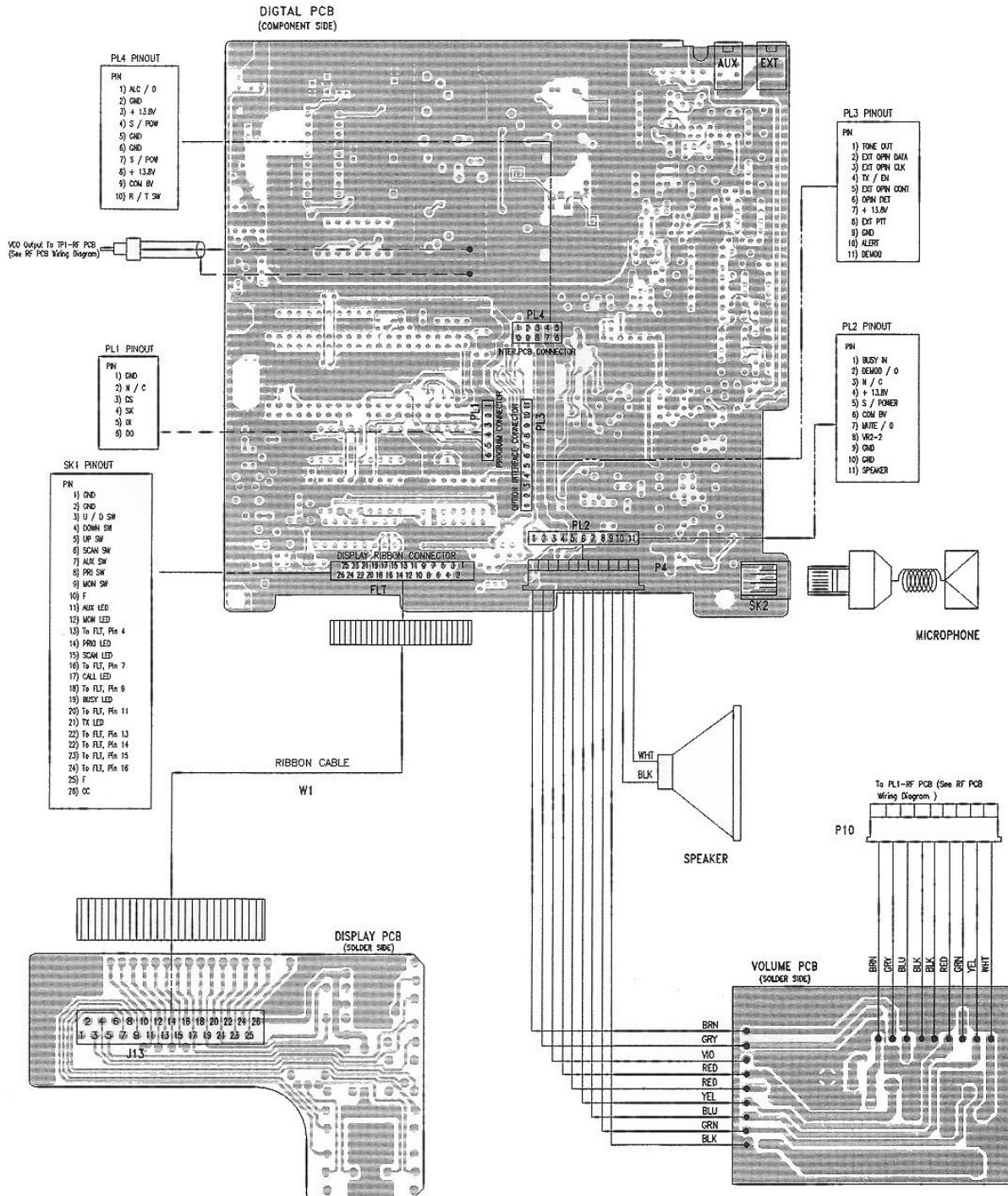

SM-4450 WIRING DIAGRAM

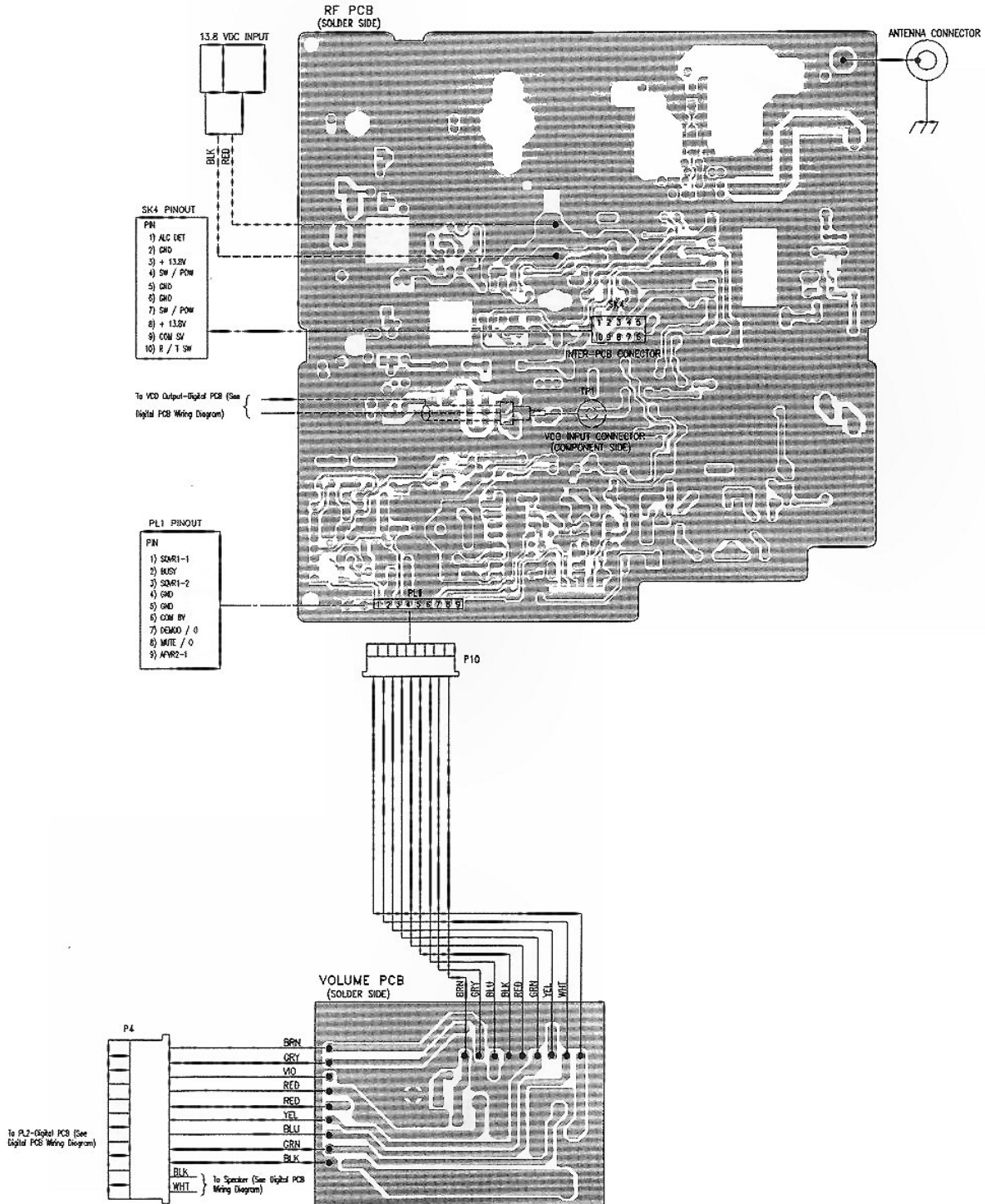

APPENDIX IV

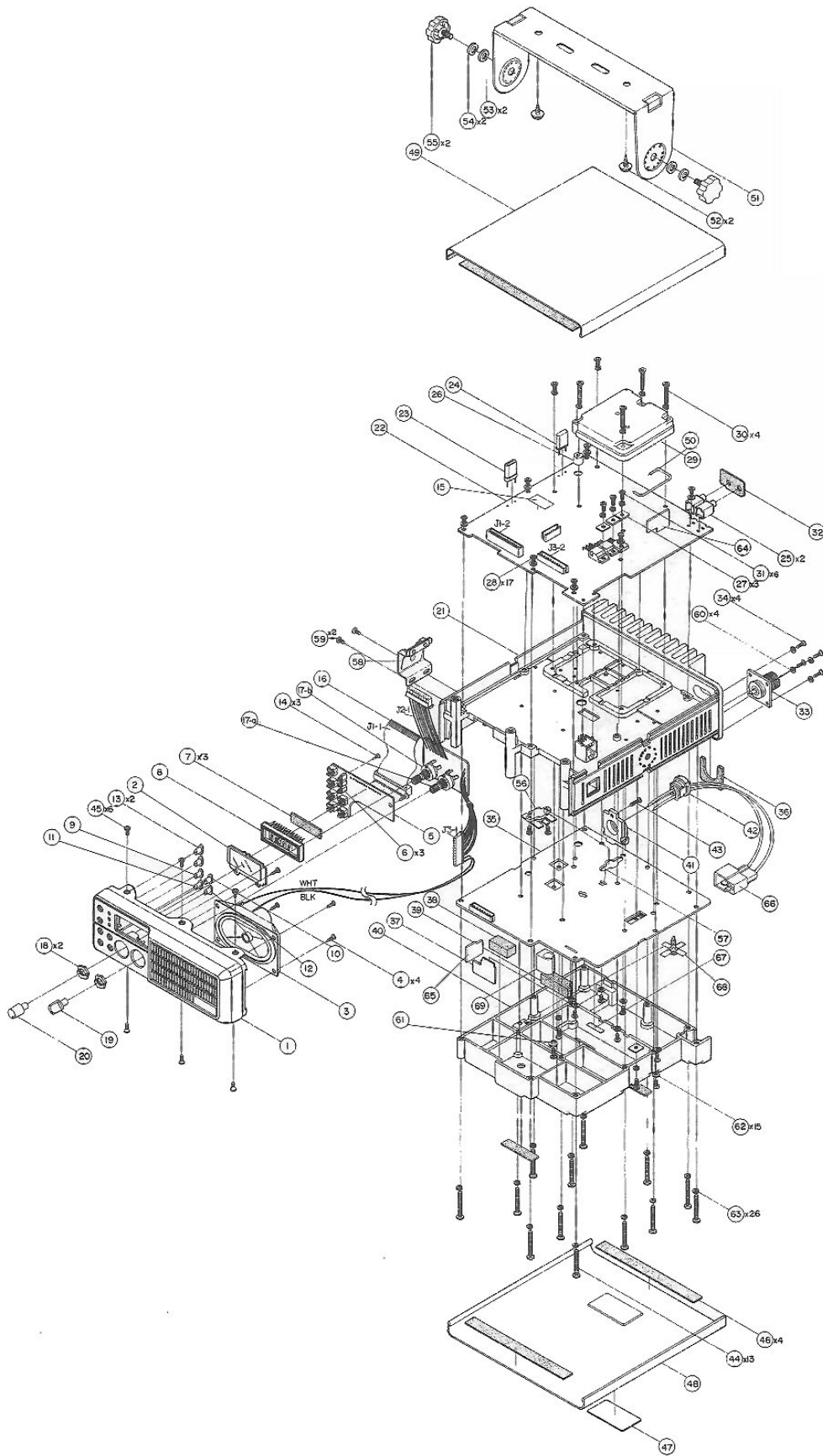

Exploded View Parts List

IDENTIFIER	PART NO.	DESCRIPTION
1	801-132-B	E.S.C.
2	813-505-A	Lens
3	420-108-4	Speaker
4	623-034	(+) Tapping Screw (P.H.) 3×6× - 1S
5	406-317-B	P.C.B Display
6	893-690	Spacer (LED)
7	893-686	Rubber Sponge
8	252-039-3	Flourescent Display
9	825-155	Knob (Function Key "S")
10	825-156	Knob (Function Key "P")
11	825-157	Knob (Function Key "1")
12	825-158	Knob (Function Key "2")
13	925-159	Knob (Function Key)
14	622-201	(+) Tapping Screw (P.H.) 2×6× - 1S
15	958-070A	Label (Check)
16	406-947-C	P.C.B Volume
17-a	450-104-0	Resistor Variable (VR)
17-b	450-105-1	Resistor Variable (VR)
18	650-220	Hexagon Nut
19	825-125	Knob (Squelch)
20	825-120	Knob (Vol.)
21	771-312-A	Frame
22	406-137-C	P.C.B Digital
23	260-866-6	Crystal Unit HC-18/U
24	260-861-1	Crystal Unit (S1-1060-0510-32)
25	420-728-5	Miniature Jack
26	650-348	Nut Ring
27	660-314	Washer (Square)
28	613-040	(+) Machine Screw (P.H.) M3×6
29	702-378	Top Panel
30	613-147	(+) Machine Screw (P.H.) M3×18
31	613-068	(+) Machine Screw (P.H.) M3×8
32	893-675	Sponge (Jack)
33	422-907-0	Connector Ant
34	613-755	(+) Machine Screw (P.H.) M3×7
35	406-136-C	P.C.B RF
36	894-110	Sponge (ANT)
37	406-973-A	P.C.B. Sq. Sub
38	894-186	Sponge (Bottom)
39	894-190	Sponge (Bottom)
40	702-023	Bottom Panel
41	723-400-C	Bracket (DC Cord)
42	750-233	Cord Stopper
43	613-314	(+) Machine Screw (B.H.) M3×8 Blk
44	613-730	(+) Machine Screw (P.H.) M3×24
45	613-192	(+) Machine Screw (F.H.) M3×6 Blk
46	905-505	Felt
47	Option	Name Plate
48	717-315-C	Cover (Bottom)
49	717-320-C	Cover (Top)

Exploded View Parts List

IDENTIFIER	PART NO.	DESCRIPTION
50	509-061	Semi-Rigid Coaxial Cables
51	723-295-B	Bracket (Set Mtg)
52	625-007	(+) Tapping Screw (T.H.) 5×12 – 1S
53	661-605	Flat Washer M6
54	662-606	Washer (Spring) M6
55	600-051	Securing Screw M6×9 Blk
56	203-186-2	Transistor
57	771-685	Shield Plate
58	508-085-A	Bracket (Mic) Ass'y
59	613-536	(+) Machine Screw (B.H.) M3×4 Blk
60	662-310	Washer (Spring) M3
61	441-004-5	Bushing
62	664-305	Washer (Lock "A" Type) M3
63	662-305	Washer (Spring) M3
64	406-969-F	P.C.B PLL Filter
65	406-968-B	P.C.B RF Filter
66	504-311	Plug Ass'y W/Cable
67	958-069-A	Label (Check)
68	203-067-8	Transistor
69	761-745	Heat Sink

APPENDIX V

SM-4450 ELECTRICAL PARTS LIST

C27	TANTALUM 2.2UF 16WW	142-201-8
C28	CERAMIC AXIAL 0.001UF:UP050B102MK	130-187-7
C29	CERAMIC AXIAL 0.001UF:UP050B102MK	130-187-7
C30	CERAMIC AXIAL 0.001UF:UP050B102MK	130-187-7
C31	CERAMIC AXIAL 0.001UF:UP050B102MK	130-187-7
C32	TANTALUM 1.0UF 16WW:DA1C010M	141-001-9
C33	TANTALUM 0.1UF 16WW:DA1C0RIM	140-101-1
C34	CERAMIC AXIAL 220PF:UP050B221K	132-248-8
C35	CERAMIC MONOLITHIC GRM42-6COG221K50M6301-500PT	132-230-1
C36	CAPACITOR ELECT 47UF 10V SM:(M) 5X11	104-711-0
C37	CERAMIC AXIAL 220PF:UP050B221K	132-248-8
C38	CAPACITOR ELECT 100UF 25V SM(M):8X11.5	101-023-7
C39	CERAMIC AXIAL 220PF:UP050B221K	132-248-8
C40	CAPACITOR ELECT 47UF 10V SM:(M) 5X11	104-711-0
C41	CERAMIC AXIAL 0.001UF:UP050B102MK	130-187-7
C42	CERAMIC AXIAL 220PF:UP050B221K	132-248-8
C43	CAPACITOR ELECT 47UF 10V SM:(M) 5X11	104-711-0
C45	CERAMIC AXIAL 220PF:UP050B221K	132-248-8
C46	CAPACITOR ELECT 47UF 10V SM:(M) 5X11	104-711-0
C47	CERAMIC AXIAL 220PF:UP050B221K	132-248-8
C48	CERAMIC AXIAL 220PF:UP050B221K	132-248-8
C49	CERAMIC AXIAL 100PF:UP050B101K	131-043-4
C50	CERAMIC AXIAL 220PF:UP050B221K	132-248-8
C51	CERAMIC AXIAL 220PF:UP050B221K	132-248-8
C52	CERAMIC AXIAL 220PF:UP050B221K	132-248-8
C53	CERAMIC AXIAL 0.001UF:UP050B102MK	130-187-7
C54	CERAMIC 39PF:2222-631-10399	133-922-8
C55	CERAMIC 100PF:2222-631-10101	131-064-3
C56	MLC AXIAL 0.1UF:SA105E104ZAA	130-164-6
C57	MLC AXIAL 0.1UF:SA105E104ZAA	130-164-6

SM-4450 ELECTRICAL PARTS LIST

IDENTIFIER	DISCRIPTION	PART NO.
C1	TANTALUM RADIAL 4.7UF:TAP4R7M16SCS	144-701-3
C1	TANTALUM DIP 0.1UF 35WV:TAM1VR10AMCB	140-104-4
C2	CERAMIC AXIAL 100PF:UP050B101K	131-043-4
C3	CERAMIC 10PF:2222-631-10109	131-067-6
C4	CERAMIC 5.6PF:2222-631-09568	135-630-4
C5	CERAMIC 6.8PF:2222-631-09688	136-826-0
C6	CERAMIC AXIAL 220PF:UP050B221K	132-248-8
C8	CAPACITOR ELECT 10UF 16V SM(M):5X11	101-012-7
C9	CERAMIC AXIAL 0.001UF:UP050B102MK	130-187-7
C10	CERAMIC AXIAL 220PF:UP050B221K	132-248-8
C11	CERAMIC AXIAL 0.001UF:UP050B102MK	130-187-7
C12	CERAMIC AXIAL 220PF:UP050B221K	132-248-8
C13	CERAMIC 10PF:2222-631-10109	131-067-6
C13	CERAMIC 10PF:2222-631-10109	131-067-6
C13	CERAMIC 15PF:2222-631-10159	131-540-6
C14	CERAMIC AXIAL 0.01UF:EP050Y103MN	130-188-8
C15	CERAMIC AXIAL 0.001UF:UP050B102MK	130-187-7
C16	CERAMIC AXIAL 0.001UF:UP050B102MK	130-187-7
C17	CERAMIC AXIAL 0.001UF:UP050B102MK	130-187-7
C18	CERAMIC AXIAL 0.001UF:UP050B102MK	130-187-7
C19	CERAMIC AXIAL 220PF:UP050B221K	132-248-8
C19	CERAMIC AXIAL 0.001UF:UP050B102MK	130-187-7
C20	CERAMIC AXIAL 220PF:UP050B221K	132-248-8
C21	CAPACITOR MYLAR 0.0022UF50WV +-5%MINI SIZE	112-212-9
C22	CAPACITOR ELECT (N.P)4.7UF16VSMBP:(M) 5X11	104-760-4
C23	CAPACITOR ELECT 10UF 16V SM(M):5X11	101-012-7
C24	CAPACITOR MYLAR 0.01UF 50WV +-5% MINI SIZE	111-004-3
C25	MLC AXIAL 0.047UF:SA205C473KAA	130-415-2
C26	CAPACITOR ELECT 22UF 16V SM:(M) 5X11	102-210-4

SM-4450 ELECTRICAL PARTS LIST

C58	MLC AXIAL 0.1UF:SA105E104ZAA	130-164-6
C59	CERAMIC AXIAL 0.001UF:UP050B102MK	130-187-7
C60	CAPACITOR CERAMIC 12PF 50VV:K "NPO"	131-204-3
C61	CAPACITOR ELECT 10UF 16V SM(M):5X11	101-012-7
C62	CERAMIC 56PF:2222-631-10569	135-624-9
C63	CAPACITOR MYLAR 0.01UF 50VV +-5% MINI SIZE	111-004-3
C64	CERAMIC AXIAL 0.001UF:UP050B102MK	130-187-7
C65	CAPACITOR MYLAR 0.0047UF50VV +-5%MINI SIZE	114-709-2
C66	CAPACITOR MYLAR 0.01UF 50VV +-5% MINI SIZE	111-004-3
C67	CAPACITOR MYLAR 0.0068UF50VV +-2%MINI SIZE	116-807-7
C68	CAPACITOR MYLAR 0.0039UF50VV +-5%MINI SIZE	113-904-6
C69	CAPACITOR MYLAR 0.0068UF50VV +-2%MINI SIZE	116-807-7
C70	CERAMIC AXIAL 0.001UF:UP050B102MK	130-187-7
C71	CERAMIC AXIAL 0.001UF:UP050B102MK	130-187-7
C72	CERAMIC AXIAL 0.01UF:EP050Y103MN	130-188-8
C73	CERAMIC AXIAL 0.001UF:UP050B102MK	130-187-7
C74	CAPACITOR ELECT 10UF 16V SM(M):5X11	101-012-7
C75	CAPACITOR MYLAR 0.047UF50VV +-2% MINI SIZE	114-713-5
C76	CAPACITOR MYLAR 0.047UF50VV +-2% MINI SIZE	114-713-5
C77	CERAMIC AXIAL 0.01UF:EP050Y103MN	130-188-8
C78	CAPACITOR ELECT 10UF 16V SM(M):5X11	101-012-7
C79	CAPACITOR MYLAR 0.047UF50VV +-2% MINI SIZE	114-713-5
C80	CAPACITOR MYLAR 0.047UF50VV +-2% MINI SIZE	114-713-5
C81	CAPACITOR ELECT 47UF 10V SM:(M) 5X11	104-711-0
C82	CERAMIC AXIAL 0.001UF:UP050B102MK	130-187-7
C83	CAPACITOR ELECT 47UF 10V SM:(M) 5X11	104-711-0
C84	CERAMIC MONOLITHIC 220PF:GRM42-6COG221J100V	132-218-1
C85	CERAMIC MONOLTHIC 91PF:GRM42-6COG910J100	139-105-7
C86	CERAMIC AXIAL 220PF:UP050B221K	132-248-8
C87	CERAMIC MONOLITHIC 220PF:GRM42-6COG221J100V	132-218-1

SM-4450 ELECTRICAL PARTS LIST

C117	CERAMIC MONOLITHIC 220PF:GRM42-6COG221J100V	132-218-1
C118	CERAMIC MONOLTHIC 91PF:GRM42-6COG910J100	139-105-7
C119	CERAMIC MONOLITHIC 27PF:GR42-6COG270J200V	132-723-0
C120	CERAMIC MONOLITHIC 27PF:GR42-6COG270J200V	132-723-0
C121	CERAMIC MONOLITHIC 24PF:GRM42-6COG240C200	132-408-6
C122	CERAMIC MONOLITHIC 2PF:GRM42-6COG020C200V	132-026-4
C123	CAPACITOR ELECT 100UF 25V SM(M):8X11.5	101-023-7
C124	CERAMIC MONOLTHIC 91PF:GRM42-6COG910J100	139-105-7
C125	CERAMIC MONOLITHIC 220PF:GRM42-6COG221J100V	132-218-1
C126	CERAMIC MONOLITHIC GR111COG330J500VM6502-400PB	133-317-2
C127	CERAMIC 39PF:GR111COG390J500	133-938-3
C130	CERAMIC MONOLITHIC GR111COG150J500VM6502-400PB	131-539-6
C131	CERAMIC MONOLITHIC GR111COG150J500VM6502-400PB	131-539-6
C132	CERAMIC MONOLITHIC GR111COG220J500VM6502-400PB	132-225-7
C133	CERAMIC MONOLITHIC GR111COG220J500VM6502-400PB	132-225-7
C136	CERAMIC MONOLITHIC GR111COG330J500VM6502-400PB	133-317-2
C137	CERAMIC MONOLITHIC GR111COG330J500VM6502-400PB	133-317-2
C138	CERAMIC 39PF:GR111COG390J500	133-938-3
C139	CERAMIC 39PF:GR111COG390J500	133-938-3
C140	CERAMIC MONOLITHIC GR111COG100D500VM6502-400PB	131-045-6
C141	CERAMIC 3.3PF:2222-631-09338	133-332-5
C142	CERAMIC MONOLITHIC GR111COG100D500VM6502-400PB	131-045-6
C143	CERAMIC MONOLITHIC 0.001UF:GRM42-6COG102J100V	130-171-1
C144	MLC CHIP 330PF:AQ14BG331JU	133-334-7
C145	CERAMIC MONOLITHIC GR111COG6R8D500VM6502-400PB	136-818-7
C146	CERAMIC MONOLITHIC GR111COG8R2D500VM6502-400PB	138-215-8
C147	CERAMIC MONOLITHIC GR111COG6R8D500VM6502-400PB	136-818-7
C148	CERAMIC MONOLITHIC GR111COG3R9C500VM6502-400PB	133-913-0
C149	CERAMIC MONOLITHIC 220PF:GRM42-6COG221J100V	132-218-1
C150	CERAMIC MONOLITHIC GR111COG330J500VM6502-400PB	133-317-2

SM-4450 ELECTRICAL PARTS LIST

C151	CERAMIC MONOLITHIC 5PF:GRM42-6COG050C200	135-019-3
C152	CERAMIC MONOLITHIC 5PF:GRM42-6COG050C200	135-019-3
C153	CERAMIC AXIAL 220PF:UP050B221K	132-248-8
C154	CERAMIC AXIAL 220PF:UP050B221K	132-248-8
C155	CERAMIC AXIAL 0.01UF:EP050Y103MN	130-188-8
C156	CERAMIC MONOLITHIC 220PF:GRM42-6COG221J100V	132-218-1
C157	CERAMIC 82PF:2222-631-10829	138-227-9
C201	CAPACITOR ELECT 1.0UF 50V SRA(M):4X7	101-007-3
C202	CERAMIC AXIAL 0.001UF:UP050B102MK	130-187-7
C203	CERAMIC AXIAL 0.01UF:EP050Y103MN	130-188-8
C204	CERAMIC AXIAL 0.01UF:EP050Y103MN	130-188-8
C205	CAPACITOR ELECT 47UF 25V SM:(M) 6.3X11	104-713-2
C206	TANTALUM 1.0UF 16VW:DA1C010M	141-001-9
C207	CAPACITOR MYLAR 0.01UF 50VW +-5% MINI SIZE	111-004-3
C208	CERAMIC AXIAL 0.01UF:EP050Y103MN	130-188-8
C209	CAPACITOR ELECT 47UF 16V SRA:(M) 6.3X7	104-739-6
C210	CAPACITOR ELECT 22UF 16V SM:(M) 5X11	102-210-4
C211	CERAMIC AXIAL 0.001UF:UP050B102MK	130-187-7
C212	CAPACITOR ELECT 470UF 16V SMS:(M) 10X12.5	104-723-1
C213	TANTALUM 0.1UF 16VW:DA1C0RIM	140-101-1
C215	TANTALUM 1.0UF 16VW:DA1C010M	141-001-9
C216	CAPACITOR ELECT 470UF 16V SMS:(M) 10X12.5	104-723-1
C217	CERAMIC AXIAL 0.001UF:UP050B102MK	130-187-7
C218	CAPACITOR ELECT (AX)1000UF 25TK SMS(M):12.5X25	101-094-1
C219	CAPACITOR MYLAR 0.1UF 50VW +-10% MINI SIZE	111-009-8
C220	CAPACITOR ELECT 10UF 16V SM(M):5X11	101-012-7
C221	CERAMIC AXIAL 0.001UF:UP050B102MK	130-187-7
C222	CAPACITOR ELECT 1.0UF 16V	101-003-9
C223	CAPACITOR ELECT 1.0UF 16V	101-003-9
C224	CAPACITOR ELECT 1.0UF 16V	101-003-9

SM-4450 ELECTRICAL PARTS LIST

C225	TANTALUM 10UF 16WW:DN1C100MIS	141-003-1
C226	CAPACITOR ELECT 470UF 16V SMS:(M) 10X12.5	104-723-1
C227	CAPACITOR MYLAR 0.1UF 50WW +-10% MINI SIZE	111-009-8
C228	CERAMIC AXIAL 0.001UF:UP050B102MK	130-187-7
C229	CERAMIC 30PF 50WW:K "NPO"	133-004-9
C230	CERAMIC 30PF 50WW:K "NPO"	133-004-9
C231	TANTALUM 10UF 16WW:DN1C100MIS	141-003-1
C232	TANTALUM 6.8UF 16WW	146-801-0
C233	CAPACITOR MYLAR 0.018UF50WW +-5% MINI SIZE	111-802-7
C234	CAPACITOR MYLAR 0.033UF50WW +-5% MINI SIZE	113-303-3
C235	CAPACITOR MYLAR 0.0018UF50WW +-5%MINI SIZE	111-803-8
C236	CAPACITOR MYLAR 0.047UF50WW +-2% MINI SIZE	114-713-5
C237	CAPACITOR POLY 820PF 50WW	128-201-2
C238	TANTALUM DIP 4.7UF 16WW:TAM1C4R7CMCB	144-702-4
C239	CERAMIC 470PF 50WW:K "B"	134-710-8
C240	TANTALUM 10UF 16WW:DN1C100MIS	141-003-1
C241	TANTALUM 10UF 16WW:DN1C100MIS	141-003-1
C242	CAPACITOR MYLAR 0.0056UF50WW +-5%MINI SIZE	115-603-4
C243	CAPACITOR MYLAR 0.047UF50WW +-2% MINI SIZE	114-713-5
C244	CERAMIC 68PF:2222-631-10689	136-825-9
C245	TANTALUM DIP 4.7UF 16WW:TAM1C4R7CMCB	144-702-4
C246	CAPACITOR MYLAR 0.018UF50WW +-5% MINI SIZE	111-802-7
C247	CAPACITOR MYLAR 0.0056UF50WW +-5%MINI SIZE	115-603-4
C248	CAPACITOR ELECT 10UF 16V SM(M):5X11	101-012-7
C249	CERAMIC MONOLITHIC 220PF:GRM40COG221J50	132-220-2
C250	CERAMIC MONOLITHIC 220PF:GRM40COG221J50	132-220-2
C251	CERAMIC MONOLITHIC 220PF:GRM40COG221J50	132-220-2
C252	CERAMIC MONOLITHIC 220PF:GRM40COG221J50	132-220-2
C253	CAPACITOR MYLAR 0.047UF50WW +-2% MINI SIZE	114-713-5
C254	CERAMIC AXIAL 0.001UF:UP050B102MK	130-187-7

SM-4450 ELECTRICAL PARTS LIST

C255	CERAMIC AXIAL 0.001UF:UP050B102MK	130-187-7
C256	CERAMIC AXIAL 0.01UF:EP050Y103MN	130-188-8
C257	CAPACITOR ELECT 10UF 16V SM(M):5X11	101-012-7
C258	CERAMIC 56PF:2222-631-10569	135-624-9
C259	CAPACITOR MYLAR 0.015UF50WV +-10%MINI SIZE	111-505-9
C260	CAPACITOR ELECT 47UF 10V SM:(M) 5X11	104-711-0
C261	CAPACITOR ELECT 10UF 16V SM(M):5X11	101-012-7
C262	CERAMIC 56PF:2222-631-10569	135-624-9
C263	CAPACITOR ELECT 22UF 16V SM:(M) 5X11	102-210-4
C264	CAPACITOR ELECT 47UF 10V SM:(M) 5X11	104-711-0
C265	CAPACITOR MYLAR 0.0056UF50WV +-5%MINI SIZE	115-603-4
C266	CAPACITOR ELECT 47UF 10V SM:(M) 5X11	104-711-0
C267	CAPACITOR MYLAR 0.0047UF50WV +-5%MINI SIZE	114-709-2
C268	CAPACITOR MYLAR 0.022UF50WV +-5% MINI SIZE	112-207-5
C269	CAPACITOR MYLAR 0.0018UF50WV +-5%MINI SIZE	111-803-8
C270	CERAMIC MONOLITHIC 220PF:GRM40COG221J50	132-220-2
C271	TANTALUM DIP 4.7UF 16WV:TAM1C4R7CMCB	144-702-4
C272	TANTALUM 1.0UF 16WV:DA1C010M	141-001-9
C274	TANTALUM 0.1UF 16WV:DA1C0RIM	140-101-1
C275	CERAMIC AXIAL 0.001UF:UP050B102MK	130-187-7
C276	CERAMIC 100PF:2222-631-10101	131-064-3
C277	CAPACITOR ELECT 47UF 10V SM:(M) 5X11	104-711-0
C278	CERAMIC MONOLITHIC GRM40X7R103J50VM6305-500PT	130-198-6
C279	TANTALUM 10UF 16WV:DN1C100MIS	141-003-1
C280	CERAMIC AXIAL 0.001UF:UP050B102MK	130-187-7
C281	CERAMIC 5.6PF:2222-631-09568	135-630-4
C282	CERAMIC 47PF:2222-631-104796	134-738-4
C283	CERAMIC MONOLITHIC 18PF:2222-631-10189	131-827-6
C284	CERAMIC MONOLITHIC 0.001UF:GRM40X7R102K50	130-184-4
C285	CERAMIC MONOLITHIC 68PF:GRM40COG680J50	136-816-5

SM-4450 ELECTRICAL PARTS LIST

C286	CERAMIC MONOLITHIC 0.001UF:GRM40X7R102K50	130-184-4
C287	CERAMIC MONOLITHIC 0.001UF:GRM40X7R102K50	130-184-4
C288	CAPACITOR ELECT 47UF 10V SM:(M) 5X11	104-711-0
C289	CERAMIC MONOLITHIC 0.001UF:GRM40X7R102K50	130-184-4
C290	CERAMIC MONOLITHIC GRM40X7R103J50VM6305-500PT	130-198-6
C291	TANTALUM 1.0UF 16WW:DA1C010M	141-001-9
C292	CERAMIC MONOLITHIC 0.001UF:GRM40X7R102K50	130-184-4
C293	CERAMIC MONOLITHIC 220PF:GRM40COG221J50	132-220-2
C294	TANTALUM 0.1UF 16WW:DA1C0RIM	140-101-1
C295	TANTALUM 0.1UF 16WW:DA1C0RIM	140-101-1
C296	CERAMIC MONOLITHIC 0.001UF:GRM40X7R102K50	130-184-4
C297	TANTALUM 10UF 16WW:DN1C100MIS	141-003-1
C298	CAPACITOR ELECT 47UF 16V SRA:(M) 6.3X7	104-739-6
C299	CERAMIC MONOLITHIC 0.001UF:GRM40X7R102K50	130-184-4
C300	CERAMIC MONOLITHIC 220PF:GRM40COG221J50	132-220-2
C301	CERAMIC MONOLITHIC 12PF:GRM40COG120J50	131-208-7
C301	CERAMIC MONOLITHIC 15PF:GRM40COG150J50	131-511-0
C302	CERAMIC MONOLITHIC 5PF:GRM40COG050C50	135-010-4
C302	CERAMIC MONOLITHIC 6PF:GRM40COG060D50	136-007-7
C303	CERAMIC MONOLITHIC 7PF:GRM40COG070D50	137-005-0
C303	CERAMIC MONOLITHIC 4PF:GRM40COG040C50	134-007-7
C304	CERAMIC MONOLITHIC 0.001UF:GRM40X7R102K50	130-184-4
C305	CAPACITOR ELECT 47UF 16V SRA:(M) 6.3X7	104-739-6
C306	CERAMIC MONOLITHIC 0.001UF:GRM40X7R102K50	130-184-4
C307	TANTALUM 10UF 16WW:DN1C100MIS	141-003-1
C308	CERAMIC MONOLITHIC 0.001UF:GRM40X7R102K50	130-184-4
C309	CERAMIC MONOLITHIC 91PF:GRM40COG910J50V	139-101-3
C310	CERAMIC MONOLITHIC 220PF:GRM40COG221J50	132-220-2
C311	CERAMIC MONOLITHIC 0.001UF:GRM40X7R102K50	130-184-4
C312	CERAMIC MONOLITHIC GRM40COG100D50VM6305-500PT	131-053-3

SM-4450 ELECTRICAL PARTS LIST

C312	CERAMIC MONOLITHIC 12PF:GRM40COG120J50	131-208-7
C313	CERAMIC MONOLITHIC 220PF:GRM40COG221J50	132-220-2
C315	CERAMIC MONOLITHIC GRM40COG100D50VM6305-500PT	131-053-3
C315	CERAMIC MONOLITHIC 8PF:GRM40COG080D50	138-004-4
C316	CERAMIC MONOLITHIC 0.5PF:GR40COG0R5D50	130-503-8
C317	CERAMIC MONOLITHIC 0.001UF:GRM40X7R102K50	130-184-4
C318	CERAMIC MONOLITHIC 220PF:GRM40COG221J50	132-220-2
C319	CERAMIC MONOLITHIC 0.001UF:GRM40X7R102K50	130-184-4
C320	CERAMIC MONOLITHIC GRM40COG2R2C50VM6305-500PT	132-227-9
C321	CERAMIC MONOLITHIC 1PF:GRM40COG010C50	131-030-2
C322	CERAMIC MONOLITHIC 220PF:GRM40COG221J50	132-220-2
C322	CERAMIC MONOLITHIC 0.5PF:GRM40COG0R5C50V	130-504-9
C323	TANTALUM 10UF 16WW:DN1C100MIS	141-003-1
C324	CERAMIC MONOLITHIC 0.001UF:GRM40X7R102K50	130-184-4
C325	CERAMIC MONOLITHIC 7PF:GRM40COG070D50	137-005-0
C325	CERAMIC MONOLITHIC GRM40COG100D50VM6305-500PT	131-053-3
C326	CERAMIC MONOLITHIC 220PF:GRM40COG221J50	132-220-2
C327	CERAMIC MONOLITHIC 5PF:GRM40COG050C50	135-010-4
C328	CERAMIC MONOLITHIC 0.001UF:GRM40X7R102K50	130-184-4
C330	CAPACITOR ELECT 47UF 16V SRA:(M) 6.3X7	104-739-6
C331	CERAMIC MONOLITHIC 0.001UF:GRM40X7R102K50	130-184-4
C332	CERAMIC MONOLITHIC 220PF:GRM40COG221J50	132-220-2
C333	CERAMIC MONOLITHIC GRM40X7R103J50VM6305-500PT	130-198-6
C401	CERAMIC MONOLITHIC 0.047UF:GRM40X7R473J25	130-425-1
C402	CERAMIC MONOLITHIC 0.047UF:GRM40X7R473J25	130-425-1
C403	CERAMIC MONOLITHIC 0.047UF:GRM40X7R473J25	130-425-1
C404	TANTALUM CHIP 10UF:293D106X0010B2T	141-046-0
C405	CERAMIC MONOLITHIC 0.047UF:GRM40X7R473J25	130-425-1
C406	CERAMIC MONOLITHIC 0.047UF:GRM40X7R473J25	130-425-1
C420	CERAMIC MONOLITHIC 0.047UF:GRM40X7R473J25	130-425-1

SM-4450 ELECTRICAL PARTS LIST

C421	CERAMIC MONOLITHIC 0.047UF:GRM40X7R473J25	130-425-1
C422	CERAMIC MONOLITHIC 0.047UF:GRM40X7R473J25	130-425-1
C423	CERAMIC MONOLITHIC 0.047UF:GRM40X7R473J25	130-425-1
C501	CERAMIC 470PF 50WW:K "B"	134-710-8
CF1	FILTER CERAMIC CFW455E	270-009-2
CF1	FILTER CERAMIC CFW455HT	270-007-0
CF1	FILTER CERAMIC CFW 455F	270-027-8
CF2	CAP.FEED THROUGH 1000PF:PLE33ANYE102P	181-005-5
D1	DIODE 1N4148	243-008-7
D1	DIODE 1N4148	243-008-7
D2	DIODE 1N4148	243-008-7
D3	DIODE 1SS133	243-011-9
D4	DIODE 1SS133	243-011-9
D6	DIODE 1SS133	243-011-9
D7	DIODE GE 1N60	244-001-5
D8	DIODE GE 1N60	244-001-5
D9	DIODE SI BA-282	243-029-6
D11	DIODE SI BA-282	243-029-6
D12	DIODE 1N4148	243-008-7
D12	SW TACT SKHQFB GRN	436-013-5
D13	DIODE 2A100V	245-008-7
D13	DIODE 1N 4001 (1A50V)	245-013-1
D15	DIODE SILICON SCHOTT1SS97	243-026-3
D16	DIODE PIN UM9401	243-016-4
D17	DIODE PIN UM9401	243-016-4
D101	DIODE 1N 4001 (1A50V)	245-013-1
D102	DIODE 1N 4001 (1A50V)	245-013-1
D103	DIODE ZENER UZ-24BM:24V 0.5W	241-111-6
D104	DIODE RED 1N5819	245-024-1
D105	DIODE ZENER UZ-4.3B:4.3V 0.5W	241-112-7

SM-4450 ELECTRICAL PARTS LIST

D106	LED LAMP SLC22GG3	251-042-0
D107	LED LAMP SLC22UR3	251-041-9
D108	SW TACT SKHQFA RED	436-012-4
D109	LED LAMP SLC-22YY3 YEL	251-069-5
D110	SW TACT SKHQFA RED	436-012-4
D111	DIODE 1N4148	243-008-7
D113	SW TACT SKHQFB GRN	436-013-5
D114	SW TACT SKHQFA RED	436-012-4
D115	SW TACT SKHQFA RED	436-012-4
D116	DIODE 1N4148	243-008-7
D117	DIODE 1N4148	243-008-7
D118	DIODE 1N4148	243-008-7
D119	DIODE ZENER 6.8V	240-021-3
D120	DIODE 1N4148	243-008-7
D121	DIODE 1N4148	243-008-7
D122	DIODE SI BB609A	243-037-3
D123	DIODE SILICON TUNINGBB515-E7906	249-051-5
D124	DIODE SILICON TUNINGBB515-E7906	249-051-5
FLT	FLUORESCENT DISPLAY 4-ST-01ZS1	252-039-3
FB1	CORE BEAD 56 59065-4B	320-536-5
FB2	CORE BEAD 56 59065-4B	320-536-5
FB3	CORE BEAD 56 59065-4B	320-536-5
FB4	CORE BEAD 56 59065-4B	320-536-5
FB5	CORE BEAD 56 59065-4B	320-536-5
FB6	CORE BEAD 56 59065-4B	320-536-5
FB7	CORE BEAD 56 59065-4B	320-536-5
FB8	CORE BEAD 56 59065-4B	320-536-5
FB9	CORE BEAD 56 59065-4B	320-536-5
IC1	IC MB3756	229-074-0
IC2	IC MC3357P	223-008-1

SM-4450 ELECTRICAL PARTS LIST

IC3	IC LM358N	231-013-8
IC4	IC LM358D SO-8	223-124-2
IC5	IC LM358N	231-013-8
IC101	IC MC7805CT	223-001-4
IC102	IC AN6540	225-004-7
IC103	IC TDA2003H	229-075-1
IC104	IC UCN 5810AF	229-383-9
IC105	IC UCN 5810AF	229-383-9
IC106	IC SN74LS257A	223-140-6
IC107	IC SMX-4000(N)	229-410-0
IC107	IC EPROM D8751H	229-113-2
IC108	IC NMC9346	231-046-8
IC108	IC CAT93C56HP	229-463-8
IC109	IC MC142100CP	223-109-9
IC110	IC LA6458S	224-022-8
IC111	IC LM358N	231-013-8
IC112	IC LA6458S	224-022-8
IC113	IC LA6458D	224-032-7
IC114	IC LA6458D	224-032-7
IC115	IC MC14066B	223-080-5
IC116	IC 78L05	223-119-8
IC117	IC MB501LPF FPT-8PIN	229-217-3
IC118	IC MC145156	223-137-4
IC119	IC MC14504B	223-152-7
IC201	IC LM358D SO-8	223-124-2
L1	SPRING COIL 3.0DIAX0.5DIAX1.5T(R)	310-720-3
L2	SPRING COIL 3.0DIAX0.5DIAX1.5T(R)	310-720-3
L3	COIL AXIAL 1MH:LAL03TB102K	310-381-0
L4	COIL AXIAL 100UH:LAL03TB101K	310-380-9
L5	COIL AXIAL 0.22UH:LAL03TBR22M	310-377-7

SM-4450 ELECTRICAL PARTS LIST

IC3	IC LM358N	231-013-8
IC4	IC LM358D SO-8	223-124-2
IC5	IC LM358N	231-013-8
IC101	IC MC7805CT	223-001-4
IC102	IC AN6540	225-004-7
IC103	IC TDA2003H	229-075-1
IC104	IC UCN 5810AF	229-383-9
IC105	IC UCN 5810AF	229-383-9
IC106	IC SN74LS257A	223-140-6
IC107	IC SMX-4000(N)	229-410-0
IC107	IC EPROM D8751H	229-113-2
IC108	IC NMC9346	231-046-8
IC108	IC CAT93C56HP	229-463-8
IC109	IC MC142100CP	223-109-9
IC110	IC LA6458S	224-022-8
IC111	IC LM358N	231-013-8
IC112	IC LA6458S	224-022-8
IC113	IC LA6458D	224-032-7
IC114	IC LA6458D	224-032-7
IC115	IC MC14066B	223-080-5
IC116	IC 78L05	223-119-8
IC117	IC MB501LPF FPT-8PIN	229-217-3
IC118	IC MC145156	223-137-4
IC119	IC MC14504B	223-152-7
IC201	IC LM358D SO-8	223-124-2
L1	SPRING COIL 3.0DIAX0.5DIAX1.5T(R)	310-720-3
L2	SPRING COIL 3.0DIAX0.5DIAX1.5T(R)	310-720-3
L3	COIL AXIAL 1MH:LAL03TB102K	310-381-0
L4	COIL AXIAL 100UH:LAL03TB101K	310-380-9
L5	COIL AXIAL 0.22UH:LAL03TBR22M	310-377-7

SM-4450 ELECTRICAL PARTS LIST

L6	COIL AXIAL 1MH:LAL03TB102K	310-381-0
L7	COIL AXIAL 0.22UH:LAL03TBR22M	310-377-7
L8	COIL AXIAL 0.82UH:LAL04TBR82M	310-383-2
L9	COIL AXIAL 0.22UH:LAL03TBR22M	310-377-7
L10	COIL AXIAL 1MH:LAL04TB102K	310-384-3
L11	COIL AXIAL 0.22UH:LAL03TBR22M	310-377-7
L12	COIL AXIAL 2.2UH:LAL03TB2R2M	310-378-8
L13	COIL AXIAL 0.22UH:LAL03TBR22M	310-377-7
L14	COIL AXIAL 0.22UH:LAL03TBR22M	310-377-7
L15	COIL AXIAL 1MH:LAL03TB102K	310-381-0
L16	COIL AXIAL 1MH:LAL03TB102K	310-381-0
L17	COIL AXIAL 1MH:LAL03TB102K	310-381-0
L18	COIL AXIAL 1MH:LAL03TB102K	310-381-0
L19	COIL AXIAL 1MH:LAL03TB102K	310-381-0
L20	COIL AXIAL 1MH:LAL03TB102K	310-381-0
L21	COIL AXIAL 0.22UH:LAL03TBR22M	310-377-7
L22	SPRING COIL 3.0DIAX0.45DIAX7.5T(L)	310-719-3
L23	COIL AXIAL 0.22UH:LAL03TBR22M	310-377-7
L24	COIL SPRING 2.4&X0.4&X6(1/2T)R	310-551-7
L25	COIL SPRING 2.4&X0.4&X6(1/2T)R	310-551-7
L26	COIL AXIAL 2.2UH:LAL03TB2R2M	310-378-8
L27	SPRING COIL 3.0DIAX0.7DIAX4.5T(L)	310-718-2
L28	COIL INDUCTOR MK-30 (100 OHM 1/2W ON 8T)	310-142-1
L29	COIL ASS'Y	509-013
L30	SPRING COIL 3.0DIAX0.65DIAX6T(R)	310-717-1
L31	COIL INDUCTOR MK-30 (100 OHM 1/2W ON 8T)	310-142-1
L32	TRANSFORMER CHOKE	300-008-1
L33	COIL INDUCTOR MK-31 (4T)	310-143-2
L34	COIL INDUCTOR MK-31 (4T)	310-143-2
L35	COIL 0.7UH 1M ON RESISTOR TYPE	310-264-8

SM-4450 ELECTRICAL PARTS LIST

L36	COIL 0.7UH 1M ON RESISTOR TYPE	310-264-8
L37	COIL AXIAL 2.2UH:LAL03TB2R2M	310-378-8
L101	COIL AXIAL 100UH:LAL03TB101K	310-380-9
L102	COIL AXIAL 100UH:LAL03TB101K	310-380-9
L103	COIL AXIAL 1UH:LAL03TB1R0M	310-379-9
L104	COIL AXIAL 1UH:LAL03TB1R0M	310-379-9
L105	COIL AXIAL 1UH:LAL03TB1R0M	310-379-9
L106	COIL AXIAL 2.2UH:LAL02TB2R2M	310-378-7
L109	SPRING COIL 3.0DIAX0.4DIAX2.5T(R)	310-722-5
L111	COIL AXIAL 1UH:LAL03TB1R0M	310-379-9
L112	COIL AXIAL 1UH:LAL03TB1R0M	310-379-9
L113	SPRING COIL 2.8DIAX0.5DIAX3.5T(R)	310-721-4
Q1	TRANSISTOR MRF9511	203-145-5
Q1	TRANSISTOR MPS9681(T)	203-009-6
Q2	FET J310	203-086-5
Q2	TRANSISTOR LSP966	203-054-6
Q3	TRANSISTOR MPS9426(C)	203-005-2
Q4	TRANSISTOR MPS9681(T)	203-009-6
Q5	TRANSISTOR MPS9631(T)	203-014-0
Q6	TRANSISTOR MPS9631(T)	203-014-0
Q7	TRANSISTOR MPS9631(T)	203-014-0
Q8	TRANSISTOR MPS9418(T)	203-010-6
Q9	TRANSISTOR KTB1367	202-066-2
Q10	TRANSISTOR LP1001	203-040-3
Q11	TRANSISTOR MRF581	203-055-7
Q12	TRANSISTOR MRF630	203-066-7
Q13	TRANSISTOR MRF654	203-067-8
Q14	TRANSISTOR SD1434	208-007-9
Q101	TRANSISTOR MPS9681(T)	203-009-6
Q102	TRANSISTOR MPS9418(T)	203-010-6

SM-4450 ELECTRICAL PARTS LIST

Q103	TRANSISTOR MPS9418(T)	203-010-6
Q104	TRANSISTOR 2N2222	203-115-8
Q105	TRANSISTOR 2N2222	203-115-8
Q106	TRANSISTOR MPS9681(T)	203-009-6
Q107	TRANSISTOR MPS9681(T)	203-009-6
Q108	TRANSISTOR MPS9631(T)	203-014-0
Q109	TRANSISTOR MPS9631(T)	203-014-0
Q110	TRANSISTOR MPS9631(T)	203-014-0
Q111	TRANSISTOR BC848BL	203-158-7
Q112	TRANSISTOR BC848BL	203-158-7
Q113	TRANSISTOR BC848BL	203-158-7
Q114	TRANSISTOR BC858BL	203-156-5
Q115	TRANSISTOR MRF5711	203-104-8
Q116	TRANSISTOR BC848BL	203-158-7
Q117	TRANSISTOR BFR92A REEL	200-003-5
Q118	FET BF998-E6327	213-006-1
Q119	TRANSISTOR BFR92A REEL	200-003-5
R1	RESISTOR METALFILM 470K OHM 1/8W +-5% "S"	002-474-5
R1	RESISTOR METALFILM 100 OHM 1/8W +-5% "S"	002-101-8
R2	RESISTOR METALFILM 22K OHM 1/8W +-5% "S"	002-223-5
R3	RESISTOR METALFILM 100 OHM 1/8W +-5% "S"	002-101-8
R4	RESISTOR METALFILM 3.9K OHM 1/8W +-5% "S"	002-392-4
R5	RESISTOR METALFILM 1.2K OHM 1/8W +-5% "S"	002-122-7
R5	RESISTOR METALFILM 910 OHM 1/8W +-5% "S"	002-911-7
R5	RESISTOR METALFILM 1.2K OHM 1/8W +-5% "S"	002-122-7
R6	RESISTOR METALFILM 100 OHM 1/8W +-5% "S"	002-101-8
R7	RESISTOR METALFILM 820 OHM 1/8W +-5% "S"	002-821-5
R7	RESISTOR METALFILM 1K OHM 1/8W +-5% "S"	002-102-9
R7	RESISTOR METALFILM 1K OHM 1/8W +-5% "S"	002-102-9
R8	RESISTOR METALFILM 8.2K OHM 1/8W +-5% "S"	002-822-6

SM-4450 ELECTRICAL PARTS LIST

R9	RESISTOR METALFILM 2.2K OHM 1/8W +-5% "S"	002-222-4
R10	RESISTOR METALFILM 3.3K OHM 1/8W +-5% "S"	002-332-0
R11	RESISTOR METALFILM 820 OHM 1/8W +-5% "S"	002-821-5
R12	RESISTOR METALFILM 68K OHM 1/8W +-5% "S"	002-683-7
R13	RESISTOR METALFILM 22K OHM 1/8W +-5% "S"	002-223-5
R14	RESISTOR METALFILM 560 OHM 1/8W +-5% "S"	002-561-0
R15	RESISTOR METALFILM 47 OHM 1/8W +-5% "S"	002-470-1
R16	RESISTOR METALFILM 2.7K OHM 1/8W +-5% "S"	002-272-9
R17	RESISTOR METALFILM 2.7K OHM 1/8W +-5% "S"	002-272-9
R18	RESISTOR METALFILM 5.1K OHM 1/8W +-5% "S"	002-512-6
R19	RESISTOR METALFILM 270 OHM 1/8W +-5% "S"	002-271-8
R20	RESISTOR METALFILM 10K OHM 1/8W +-5% "S"	002-103-0
R21	RESISTOR METALFILM 2.2K OHM 1/8W +-5% "S"	002-222-4
R22	RESISTOR METALFILM 47K OHM 1/8W +-5% "S"	002-473-4
R23	RESISTOR METALFILM 270 OHM 1/8W +-5% "S"	002-271-8
R23	RESISTOR METALFILM 10K OHM 1/8W +-5% "S"	002-103-0
R24	RESISTOR METALFILM 2.2K OHM 1/8W +-5% "S"	002-222-4
R25	RESISTOR METALFILM 10K OHM 1/8W +-5% "S"	002-103-0
R26	RESISTOR METALFILM 4.7K OHM 1/8W +-5% "S"	002-472-3
R27	RESISTOR METALFILM 1.2K OHM 1/8W +-5% "S"	002-122-7
R28	RESISTOR METALFILM 390 OHM 1/8W +-5% "S"	002-391-3
R29	RESISTOR METALFILM 330 OHM 1/8W +-5% "S"	002-331-9
R30	RESISTOR METALFILM 470 OHM 1/8W +-5% "S"	002-471-2
R31	RESISTOR METALFILM 1.5K OHM 1/8W +-5% "S"	002-152-4
R31	RESISTOR METALFILM 2K OHM 1/8W +-5% "S"	002-202-6
R31	RESISTOR METALFILM 2.2K OHM 1/8W +-5% "S"	002-222-4
R32	RESISTOR METALFILM 2K OHM 1/8W +-5% "S"	002-202-6
R32	RESISTOR METALFILM 1.5K OHM 1/8W +-5% "S"	002-152-4
R32	RESISTOR METALFILM 2.2K OHM 1/8W +-5% "S"	002-222-4
R33	RESISTOR METALFILM 47K OHM 1/8W +-5% "S"	002-473-4

SM-4450 ELECTRICAL PARTS LIST

R34	RESISTOR METALFILM 33K OHM 1/8W +-5% "S"	002-333-1
R35	RESISTOR METALFILM 100 OHM 1/8W +-5% "S"	002-101-8
R36	RESISTOR METALFILM 1K OHM 1/8W +-5% "S"	002-102-9
R37	RESISTOR METALFILM 3.3K OHM 1/8W +-5% "S"	002-332-0
R38	RESISTOR METALFILM 33K OHM 1/8W +-5% "S"	002-333-1
R39	RESISTOR METALFILM 39K OHM 1/8W +-5% "S"	002-393-5
R40	RESISTOR METALFILM 4.43K OHM 1/8W +-1% "S"	014-443-1
R41	RESISTOR METALFILM 2.42K OHM 1/8W +-1% "S"	014-242-1
R42	RESISTOR METALFILM 2K OHM 1/8W +-2% "S"	016-202-9
R43	RESISTOR METALFILM 21.3K OHM 1/8W +-1% "S"	014-213-1
R44	RESISTOR METALFILM 10K OHM 1/8W +-5% "S"	002-103-0
R45	RESISTOR METALFILM 1K OHM 1/8W +-5% "S"	002-102-9
R46	RESISTOR METALFILM 220 OHM 1/8W +-5% "S"	002-221-3
R47	RESISTOR METALFILM 8.2K OHM 1/8W +-5% "S"	002-822-6
R48	RESISTOR METALFILM 3.3K OHM 1/8W +-5% "S"	002-332-0
R49	RESISTOR METALFILM 1M OHM 1/8W +-5% "S"	002-105-2
R50	RESISTOR METALFILM 1.2K OHM 1/8W +-5% "S"	002-122-7
R51	RESISTOR METALFILM 150 OHM 1/2W +-5% "S" MINI	030-151-2
R52	RESISTOR METALFILM 330 OHM 1/2W +-5% "S" MINI	030-331-8
R53	RESISTOR METALFILM 1.8K OHM 1/2W +-5% "S"	030-182-0
R56	RESISTOR METALFILM 1K OHM 1/8W +-5% "S"	002-102-9
R57	RESISTOR CHIP 100 OHM 1/10W +-5%	060-101-6
R58	RESISTOR METALFILM 1K OHM 1/8W +-5% "S"	002-102-9
R59	RESISTOR METALFILM 4.7 OHM 1/8W +-5% "S"	002-479-0
R60	RESISTOR METALFILM 1K OHM 1/8W +-5% "S"	002-102-9
R61	RESISTOR METALFILM 3.3 OHM 1/8W +-5% "S"	002-339-7
R62	RESISTOR METALFILM 100 OHM 1/8W +-5% "S"	002-101-8
R63	RESISTOR METALFILM 3.3K OHM 1/8W +-5% "S"	002-332-0
R64	RESISTOR METALFILM 330 OHM 1/8W +-5% "S"	002-331-9
R65	RESISTOR METALFILM 820 OHM 1/8W +-5% "S"	002-821-5

SM-4450 ELECTRICAL PARTS LIST

R66	RESISTOR METALFILM 27 OHM 1/8W +-5% "S"	002-270-7
R67	RESISTOR METALOXIDE 33 OHM 1W +-5%	018-330-1
R68	RESISTOR METALFILM 2.2 OHM 1/8W +-5% "S"	002-229-1
R69	RESISTOR METALFILM 100 OHM1/2W +-5% S MINI	030-101-7
R70	RESISTOR METALFILM 100 OHM1/2W +-5% S MINI	030-101-7
R71	RESISTOR METALFILM 1K OHM 1/8W +-5% "S"	002-102-9
R201	RESISTOR METALFILM 5.6K OHM 1/8W +-5% "S"	002-562-1
R202	RESISTOR METALFILM 22K OHM 1/8W +-5% "S"	002-223-5
R203	RESISTOR METALFILM 10K OHM 1/8W +-5% "S"	002-103-0
R204	RESISTOR METALFILM 120 OHM 1/8W +-5% "S"	002-121-6
R205	RESISTOR METALFILM 100 OHM 1/8W +-5% "S"	002-101-8
R206	RESISTOR METALFILM 330 OHM 1/8W +-5% "S"	002-331-9
R207	RESISTOR METALFILM 47K OHM 1/8W +-5% "S"	002-473-4
R208	RESISTOR METALFILM 15K OHM 1/8W +-5% "S"	002-153-5
R209	RESISTOR METALFILM 68 OHM 1/8W +-5% "S"	002-680-4
R210	RESISTOR METALFILM 22K OHM 1/8W +-5% "S"	002-223-5
R211	RESISTOR METALFILM 8.2K OHM 1/8W +-5% "S"	002-822-6
R212	RESISTOR METALFILM 10K OHM 1/8W +-5% "S"	002-103-0
R213	RESISTOR METALFILM 220 OHM 1/8W +-5% "S"	002-221-3
R214	RESISTOR METALFILM 220 OHM 1/8W +-5% "S"	002-221-3
R215	RESISTOR METALFILM 4.7K OHM 1/8W +-5% "S"	002-472-3
R216	RESISTOR METALFILM 10K OHM 1/8W +-5% "S"	002-103-0
R217	RESISTOR METALFILM 10K OHM 1/8W +-5% "S"	002-103-0
R218	RESISTOR METALFILM 10K OHM 1/8W +-5% "S"	002-103-0
R219	RESISTOR METALFILM 100K OHM 1/8W +-5% "S"	002-104-1
R220	RESISTOR METALFILM 10K OHM 1/8W +-5% "S"	002-103-0
R221	RESISTOR METALFILM 10K OHM 1/8W +-5% "S"	002-103-0
R222	RESISTOR METALFILM 47 OHM 1/8W +-5% "S"	002-470-1
R223	RESISTOR METALFILM 8.2K OHM 1/8W +-5% "S"	002-822-6
R223	RESISTOR METALFILM 8.2K OHM 1/8W +-5% "S"	002-822-6

SM-4450 ELECTRICAL PARTS LIST

R223	RESISTOR METALFILM 22K OHM 1/8W +-5% "S"	002-223-5
R224	RESISTOR CARBONFILM 2.2 OHM 1/5W +-5%	013-229-9
R225	RESISTOR METALFILM 3.3 OHM 1/8W +-5% "S"	002-339-7
R226	RESISTOR METALFILM 3.3 OHM 1/8W +-5% "S"	002-339-7
R227	RESISTOR METALFILM 3.3 OHM 1/8W +-5% "S"	002-339-7
R228	RESISTOR METALFILM 3.3 OHM 1/8W +-5% "S"	002-339-7
R229	RESISTOR METALFILM 3.3 OHM 1/8W +-5% "S"	002-339-7
R230	RESISTOR METALFILM 3.3 OHM 1/8W +-5% "S"	002-339-7
R231	RESISTOR METALFILM 3.3 OHM 1/8W +-5% "S"	002-339-7
R232	RESISTOR METALFILM 3.3 OHM 1/8W +-5% "S"	002-339-7
R234	RESISTOR METALFILM 10K OHM 1/8W +-5% "S"	002-103-0
R235	RESISTOR METALFILM 10K OHM 1/8W +-5% "S"	002-103-0
R236	RESISTOR METALFILM 10K OHM 1/8W +-5% "S"	002-103-0
R237	RESISTOR METALFILM 10K OHM 1/8W +-5% "S"	002-103-0
R238	RESISTOR METALFILM 10K OHM 1/8W +-5% "S"	002-103-0
R239	RESISTOR METALFILM 2.2K OHM 1/8W +-5% "S"	002-222-4
R240	RESISTOR METALFILM 2.2K OHM 1/8W +-5% "S"	002-222-4
R241	RESISTOR METALFILM 2.2K OHM 1/8W +-5% "S"	002-222-4
R242	RESISTOR METALFILM 24K OHM 1/8W +-5% "S"	002-243-3
R243	RESISTOR METALFILM 18K OHM 1/8W +-5% "S"	002-183-2
R244	RESISTOR METALFILM 56K OHM 1/8W +-5% "S"	002-563-2
R245	RESISTOR METALFILM 10K OHM 1/8W +-5% "S"	002-103-0
R246	RESISTOR METALFILM 100K OHM 1/8W +-5% "S"	002-104-1
R247	RESISTOR METALFILM 100K OHM 1/8W +-5% "S"	002-104-1
R248	RESISTOR METALFILM 100K OHM 1/8W +-5% "S"	002-104-1
R249	RESISTOR METALFILM 100K OHM 1/8W +-5% "S"	002-104-1
R250	RESISTOR METALFILM 100K OHM 1/8W +-5% "S"	002-104-1
R251	RESISTOR METALFILM 100K OHM 1/8W +-5% "S"	002-104-1
R252	RESISTOR METALFILM 100K OHM 1/8W +-5% "S"	002-104-1
R253	RESISTOR METALFILM 2.2K OHM 1/8W +-5% "S"	002-222-4

SM-4450 ELECTRICAL PARTS LIST

R254	RESISTOR METALFILM 10K OHM 1/8W +-5% "S"	002-103-0
R255	RESISTOR METALFILM 220K OHM 1/8W +-5% "S"	002-224-6
R256	RESISTOR METALFILM 3.3K OHM 1/8W +-5% "S"	002-332-0
R257	RESISTOR METALFILM 4.7K OHM 1/8W +-5% "S"	002-472-3
R258	RESISTOR METALFILM 5.6K OHM 1/8W +-5% "S"	002-562-1
R259	RESISTOR METALFILM 47K OHM 1/8W +-5% "S"	002-473-4
R260	RESISTOR METALFILM 4.7K OHM 1/8W +-5% "S"	002-472-3
R261	RESISTOR METALFILM 3.9K OHM 1/8W +-5% "S"	002-392-4
R262	RESISTOR METALFILM 1K OHM 1/8W +-5% "S"	002-102-9
R263	RESISTOR METALFILM 4.7K OHM 1/8W +-5% "S"	002-472-3
R264	RESISTOR METALFILM 4.7K OHM 1/8W +-5% "S"	002-472-3
R265	RESISTOR METALFILM 4.7K OHM 1/8W +-5% "S"	002-472-3
R266	RESISTOR METALFILM 4.7K OHM 1/8W +-5% "S"	002-472-3
R267	RESISTOR METALFILM 4.7K OHM 1/8W +-5% "S"	002-472-3
R268	RESISTOR METALFILM 4.7K OHM 1/8W +-5% "S"	002-472-3
R269	RESISTOR METALFILM 4.7K OHM 1/8W +-5% "S"	002-472-3
R270	RESISTOR METALFILM 4.7K OHM 1/8W +-5% "S"	002-472-3
R271	RESISTOR METALFILM 1 OHM 1/8W +-5% "S"	002-109-6
R272	RESISTOR METALFILM 1K OHM 1/8W +-5% "S"	002-102-9
R273	RESISTOR METALFILM 10K OHM 1/8W +-5% "S"	002-103-0
R274	RESISTOR METALFILM 390K OHM 1/8W +-5% "S"	002-394-6
R275	RESISTOR METALFILM 680K OHM 1/8W +-5% "S"	002-684-8
R276	RESISTOR METALFILM 680K OHM 1/8W +-5% "S"	002-684-8
R277	RESISTOR METALFILM 10K OHM 1/8W +-5% "S"	002-103-0
R278	RESISTOR METALFILM 680K OHM 1/8W +-5% "S"	002-684-8
R279	RESISTOR METALFILM 220K OHM 1/8W +-5% "S"	002-224-6
R280	RESISTOR METALFILM 150K OHM 1/8W +-5% "S"	002-154-6
R281	RESISTOR METALFILM 82K OHM 1/8W +-5% "S"	002-823-7
R282	RESISTOR METALFILM 5.6K OHM 1/8W +-5% "S"	002-562-1
R283	RESISTOR METALFILM 3.3K OHM 1/8W +-5% "S"	002-332-0

SM-4450 ELECTRICAL PARTS LIST

R284	RESISTOR METALFILM 620 OHM 1/8W +-5% "S"	002-621-1
R285	RESISTOR METALFILM 22K OHM 1/8W +-5% "S"	002-223-5
R286	RESISTOR METALFILM 240K OHM 1/8W +-5% "S"	002-244-4
R287	RESISTOR METALFILM 1.5K OHM 1/8W +-5% "S"	002-152-4
R288	RESISTOR METALFILM 27K OHM 1/8W +-5% "S"	002-273-0
R289	RESISTOR METALFILM 33K OHM 1/8W +-5% "S"	002-333-1
R290	RESISTOR METALFILM 1.5K OHM 1/8W +-5% "S"	002-152-4
R291	RESISTOR METALFILM 270K OHM 1/8W +-5% "S"	002-274-1
R292	RESISTOR METALFILM 1.5K OHM 1/8W +-5% "S"	002-152-4
R292	RESISTOR METALFILM 1.5K OHM 1/8W +-5% "S"	002-152-4
R293	RESISTOR METALFILM 10K OHM 1/8W +-5% "S"	002-103-0
R294	RESISTOR METALFILM 10K OHM 1/8W +-5% "S"	002-103-0
R295	RESISTOR METALFILM 4.7K OHM 1/8W +-5% "S"	002-472-3
R296	RESISTOR METALFILM 10K OHM 1/8W +-5% "S"	002-103-0
R297	RESISTOR METALFILM 10K OHM 1/8W +-5% "S"	002-103-0
R298	RESISTOR METALFILM 47K OHM 1/8W +-5% "S"	002-473-4
R299	RESISTOR METALFILM 5.6K OHM 1/8W +-5% "S"	002-562-1
R300	RESISTOR METALFILM 10K OHM 1/8W +-5% "S"	002-103-0
R301	RESISTOR METALFILM 10K OHM 1/8W +-5% "S"	002-103-0
R302	RESISTOR METALFILM 3.9K OHM 1/8W +-5% "S"	002-392-4
R303	RESISTOR CHIP 22K OHM 1/10W +-5%	060-223-3
R304	RESISTOR CHIP 22K OHM 1/10W +-5%	060-223-3
R305	RESISTOR CHIP 22K OHM 1/10W +-5%	060-223-3
R306	RESISTOR CHIP 56K OHM 1/10W +-5%	060-563-0
R307	RESISTOR METALFILM 1M OHM 1/4W +-5% "S"	009-105-7
R308	RESISTOR METALFILM 12K OHM 1/8W +-5% "S"	002-123-8
R309	RESISTOR METALFILM 3.3K OHM 1/8W +-5% "S"	002-332-0
R310	RESISTOR METALFILM 1.5K OHM 1/8W +-5% "S"	002-152-4
R311	RESISTOR METALFILM 22K OHM 1/8W +-5% "S"	002-223-5
R312	RESISTOR METALFILM 47K OHM 1/8W +-5% "S"	002-473-4

SM-4450 ELECTRICAL PARTS LIST

R313	RESISTOR CHIP 2.2K OHM 1/10W +-5%	060-222-2
R314	RESISTOR CHIP 3.9K OHM 1/10W +-5%	060-392-2
R315	RESISTOR CHIP 6.8K OHM 1/10W +-5%	060-682-4
R316	RESISTOR CHIP 2.7K OHM 1/10W +-5%	060-272-7
R317	RESISTOR CHIP 15K OHM 1/10W +-5%	060-153-3
R318	RESISTOR CHIP 10 OHM 1/10W +-5%	060-100-5
R319	RESISTOR CHIP 1K OHM 1/10W +-5%	060-102-7
R320	RESISTOR CHIP 4.7K OHM 1/10W +-5%	060-472-1
R321	RESISTOR CHIP 1.2K OHM 1/10W +-5%	060-122-5
R322	RESISTOR CHIP 1.2K OHM 1/10W +-5%	060-122-5
R323	RESISTOR CHIP 10 OHM 1/10W +-5%	060-100-5
R324	RESISTOR METALFILM 47 OHM 1/8W +-5% "S"	002-470-1
R325	RESISTOR CHIP 5.6K OHM 1/10W +-5%	060-562-9
R326	RESISTOR CHIP 1.8K OHM 1/10W +-5%	060-182-9
R327	RESISTOR CHIP 220 OHM 1/10W +-5%	060-221-1
R328	RESISTOR CHIP 2.2K OHM 1/10W +-5%	060-222-2
R329	RESISTOR CHIP 47 OHM 1/10W +-5%	060-470-9
R330	RESISTOR CHIP 10 OHM 1/10W +-5%	060-100-5
R331	RESISTOR CHIP 8.2K OHM 1/10W +-5%	060-822-4
R332	RESISTOR CHIP 5.6K OHM 1/10W +-5%	060-562-9
R333	RESISTOR CHIP 220 OHM 1/10W +-5%	060-221-1
R334	RESISTOR CHIP 100K OHM 1/10W +-5%	060-104-9
R335	RESISTOR CHIP 82K OHM 1/10W +-5%	060-823-5
R336	RESISTOR CHIP 22K OHM 1/10W +-5%	060-223-3
R337	RESISTOR CHIP 8.2K OHM 1/10W +-5%	060-822-4
R338	RESISTOR CHIP 5.6K OHM 1/10W +-5%	060-562-9
R339	RESISTOR CHIP 180 OHM 1/10W +-5%	060-181-8
R340	RESISTOR CHIP 3.9K OHM 1/10W +-5%	060-392-2
R341	RESISTOR CHIP 0 OHM 1/10W +-5%	060-000-8
R342	RESISTOR METALFILM 10 OHM 1/8W +-5% "S"	002-100-7

SM-4450 ELECTRICAL PARTS LIST

R343	RESISTOR CHIP 1K OHM 1/10W +-5%	060-102-7
R344	RESISTOR METALFILM 470 OHM 1/8W +-5% "S"	002-471-2
R401	RESISTOR CHIP 56K OHM 1/10W +-5%	060-563-0
R402	RESISTOR CHIP 10K OHM 1/10W +-5%	060-103-8
R403	RESISTOR CHIP 33K OHM 1/10W +-5%	060-333-9
R404	RESISTOR CHIP 4.7K OHM 1/10W +-5%	060-472-1
R405	RESISTOR CHIP 100K OHM 1/10W +-5%	060-104-9
R406	RESISTOR CHIP 3.3K OHM 1/10W +-5%	060-332-8
R407	RESISTOR CHIP 270K OHM 1/10W +-5%	060-274-9
R420	RESISTOR CHIP 1.2K OHM 1/10W +-5%	060-122-5
R421	RESISTOR CHIP 120 OHM 1/10W +-5%	060-121-4
R422	RESISTOR CHIP 68K OHM 1/10W +-5%	060-683-5
R423	RESISTOR CHIP 12K OHM 1/10W +-5%	060-123-6
R424	RESISTOR CHIP 470 OHM 1/10W +-5%	060-471-0
R425	RESISTOR CHIP 33 OHM 1/10W +-5%	060-330-6
R426	RESISTOR CHIP 270K OHM 1/10W +-5%	060-274-9
R427	RESISTOR CHIP 8.2K OHM 1/10W +-5%	060-822-4
RA1	RESISTOR ARRAY MHR-8-103JA:10KX8 9PIN	069-023-4
RA2	RESISTOR ARRAY MHR-8-103JA:10KX8 9PIN	069-023-4
RA3	RESISTOR ARRAY MHR-8-103JA:10KX8 9PIN	069-023-4
RV2	RESISTOR SEMIFIXED 10KB:RH0651C100103	071-103-6
RV3	RESISTOR SEMIFIXED 10KB:RH0621C100138	072-103-1
RV4	RESISTOR SEMIFIXED 4.7KB:RH0651C100472	071-472-9
RV4	RESISTOR SEMIFIXED 4.7KB:RH0651C100472	071-472-9
RV4	RESISTOR SEMIFIXED 10KB:RH0621C100138	072-103-1
RV4	RESISTOR SEMIFIXED 10KB:RH0651C100103	071-103-6
RV5	RESISTOR SEMIFIXED 22KB:RH0651C100223	071-223-1
RY1	RELAY OUC-SS-105D 5V	420-648-6
RV401	RESISTOR SEMIFIXED 2.2KB:RH0614C100222	070-222-5
T1	FILTER HELICAL 460MHZ	320-960-6

SM-4450 ELECTRICAL PARTS LIST

T2	FILTER HELICAL 460MHZ	320-960-6
T3	FILTER HELICAL 460MHZ	320-960-6
T4	COIL IFT 21.4MHZ(A)	320-572-9
T4	COIL IFT 21.4MHZ(A)	320-572-9
T4	COIL IFT 21.4MHZ UK A	320-717-5
T5	FILTER HELICAL 440MHZ	320-961-7
T6	COIL IFT 21.4MHZ UK B	320-718-6
T6	COIL IFT 21.4MHZ(B)	320-573-0
T6	COIL IFT 21.4MHZ(B)	320-573-0
T7	COIL 455KHZ DET	320-426-1
T101	TRANSFORMER DC-DC CONVERTOR	300-135-2
TC11	CAPACITOR TRIMMER TZ03Z100ER 169	171-014-0
TC12	CAPACITOR TRIMMER TZ03Z100ER 169	171-014-0
TC13	CAPACITOR TRIMMER 10P(N):ECR-MN010C13	171-011-7
TC14	CAPACITOR TRIMMER 10PF:ECV-1ZW10X53T	171-013-9
TH1	THERMISTOR 2.5K OHM +-15%:KTD5-225	098-252-8
TH1	THERMISTOR 50K OHM +-15%:YTD5-350	097-503-0
TH2	THERMISTOR 100 OHM +-15%:KTD5-110	098-101-5
TH2	THERMISTOR 1K OHM +-15%:KTD5-210	097-102-1
TH3	THERMISTOR 30K OHM +-15%:KTD5-330	099-303-6
VR1	RESISTOR VARIABLE 171PN2-4 C10K12KC	450-104-0
VR2	RESISTOR VARIABLE 171PS2-4 A10K12KC	450-105-1
X1	CRYSTAL UNIT HC-18/U8.2944MHZ:703142	260-866-6
X1	X-TAL UNIT(S1-1060-1NR-18 20.945MHZ	260-862-2
X2	CRYSTAL UNIT NC-18C12.800MHZ(S1-1060-0510)	261-394-2
X2	CRYSTAL UNIT NC-18C12.800MHZ(S1-1060-0510)	261-394-2
X2	X-TAL UNIT(S1-1060-0NC-18C 10.240MHZ	260-861-1
XF1	FILTER CRYSTAL 21F7.5B	271-013-0
XF1	FILTER CRYSTAL 21F15B(21.4MHZ)	271-011-8
XF1	FILTER CRYSTAL 21F15B(21.4MHZ)	271-011-8

APPENDIX VI

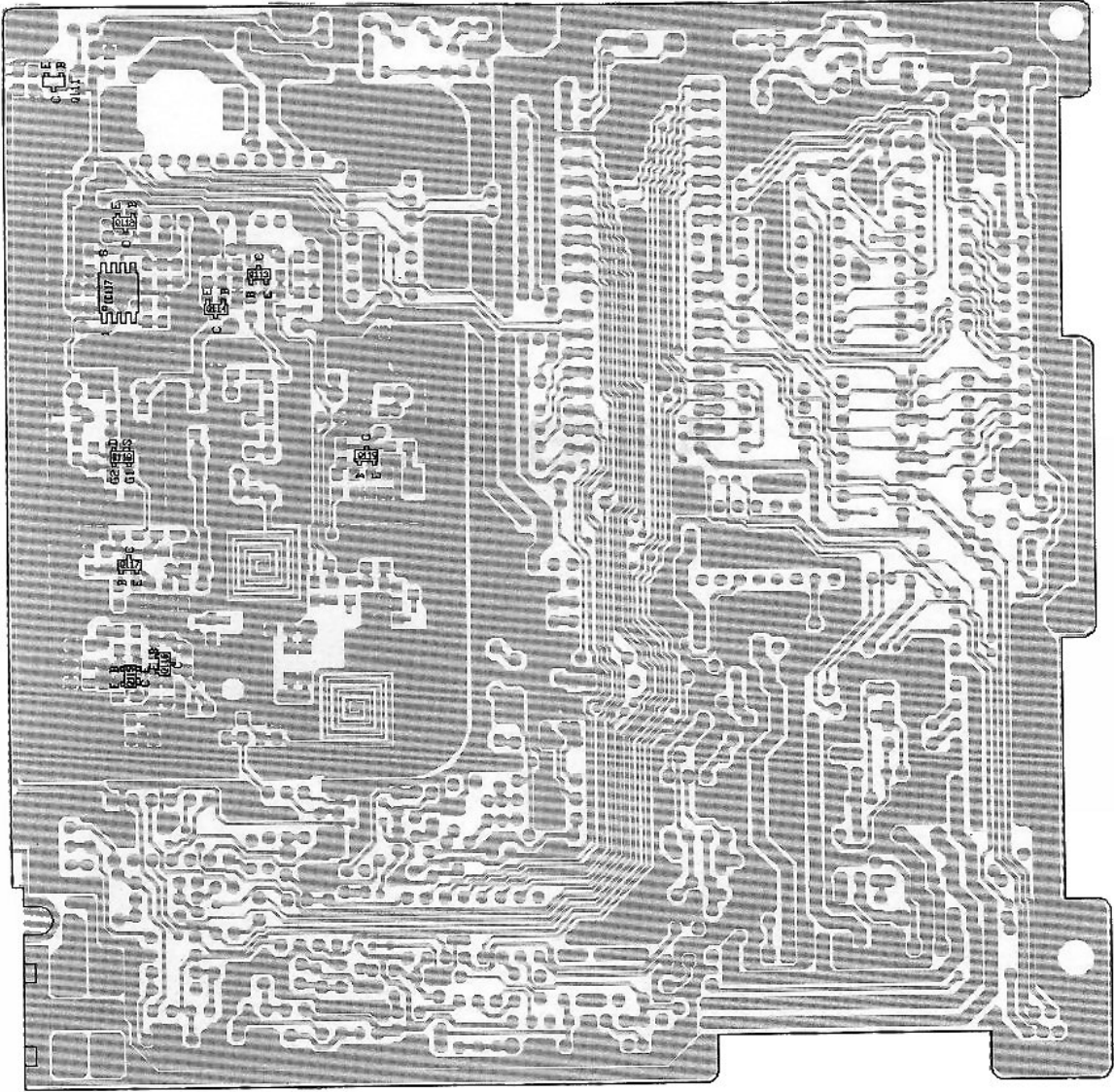

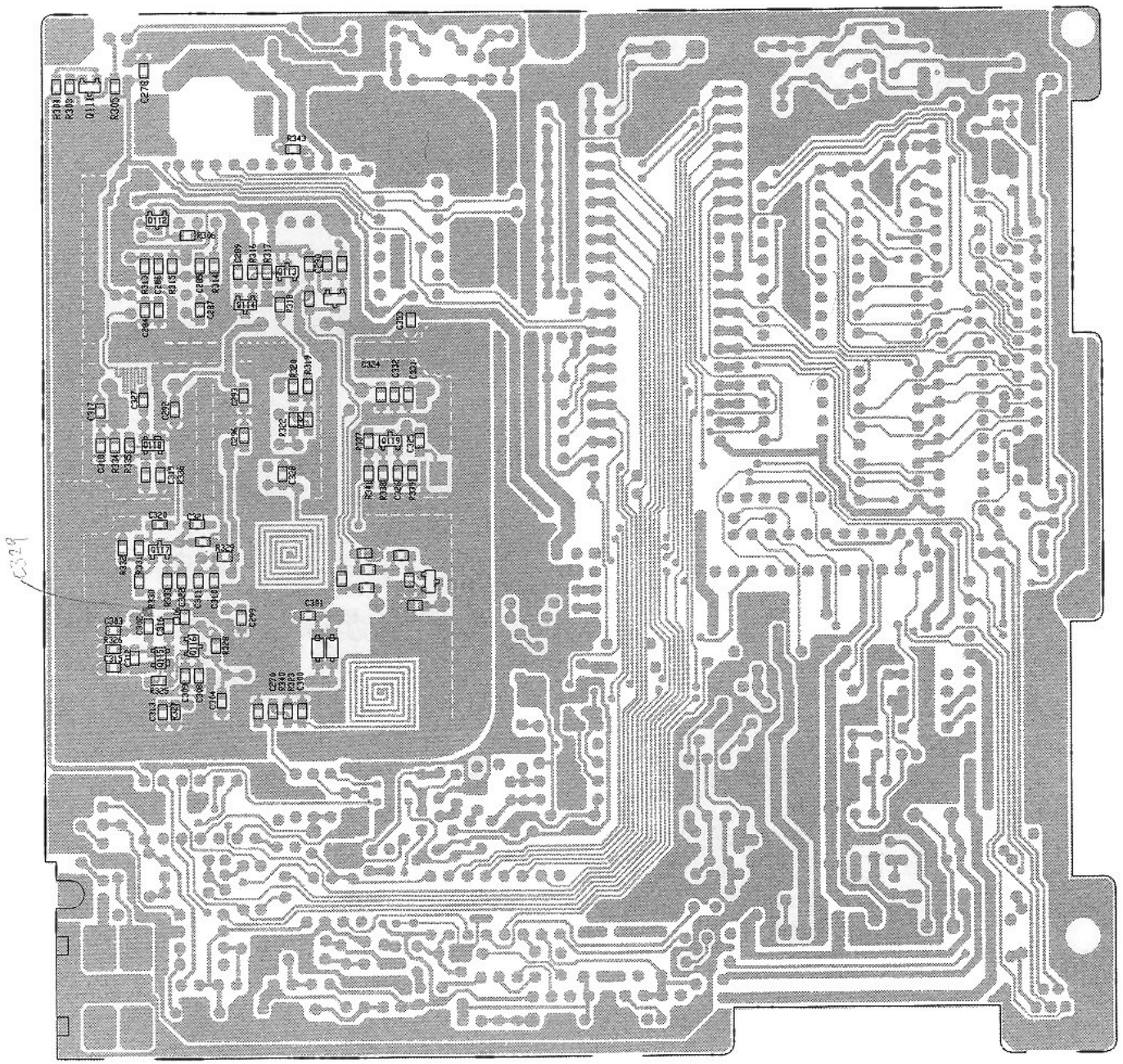

DIGITAL PCB (BOTTOM)

MAXON SM-4450 UHF SYNTHESIZED MOBILE
VOLTAGE CHART-RF PCB

IC1

NO	RX	TX
1	8.1	8.1
2	13.7	13.1
3	8.1	8.1
4	0	0
5	4.3	0
6	8.1	2.5
7	2.6	8.1
8	0	8.1

Q3

NO	RX	TX
B	2.23	0.11
E	1.51	0
C	3.94	0

Q13

NO	RX	TX
E	0	0
F	0	0
C	3.6	10.35

Q4

NO	RX	TX
C	7.15	7.11
E	6.67	6.44
B	2.77	4.14

Q14

NO	RX	TX
E	0	0
B	0	0
C	13.8	12.97

IC2

NO	RX		TX
	UNSQ	SQ	
1	7.8	7.8	0
2	7.2	7.2	0
3	7.5	7.5	0
4	7.8	7.8	0
5	1.0	1.0	0
6	1.0	1.0	0
7	1.0	1.0	0
8	7.8	7.8	0
9	0.7	0.7	0.3
10	1.9	1.9	0.6
11	1.9	1.9	1.1
12	0	1.2	0.1
13	7.1	0	0
14	0	0	0.8
15	0	0	0
16	2	2	0

Q6

NO	RX		TX
	UNSQ	SQ	
E	0	0	0
B	0.06	0.86	0.84
C	0.29	0	0.03

Q7

NO	RX	TX
C	8.09	8.12
B	3.75	0.17
E	3.12	0

Q8

NO	RX	TX
E	0	1.81
B	0.01	2.43
C	13.82	8.64

Q9

NO	RX	TX
E	13.8	12.5
C	3.6	10.4
B	13.8	13.2

IC3

NO	RX	TX
1	4.3	4.3
2	4.3	4.3
3	4.3	4.3
4	0	0
5	4.3	4.3
6	4.3	4.3
7	4.3	4.3
8	8.4	8.4

Q10

NO	RX	TX
B	0.02	0.53
E	0	0
C	0.13	6.8

Q11

NO	RX	TX
E	0	0
B	0.13	0.83
C	0.13	7.24

IC5

NO	RX	TX
1	0	1.0
2	1.4	2.1
3	0	2.1
4	0	0
5	0.2	0.3
6	0.2	0.3
7	6.9	7.1
8	8.1	8.1

Q12

NO	RX		TX
	UNSQ	SQ	
C	13.7	13.7	12.5
B	0	0	0
E	0	0	0

Q13

NO	RX	TX
G	0.79	1.0
S	2.31	0.25
D	7.67	0.18

Q2

NO	RX	TX
G	0.79	1.0
S	2.31	0.25
D	7.67	0.18

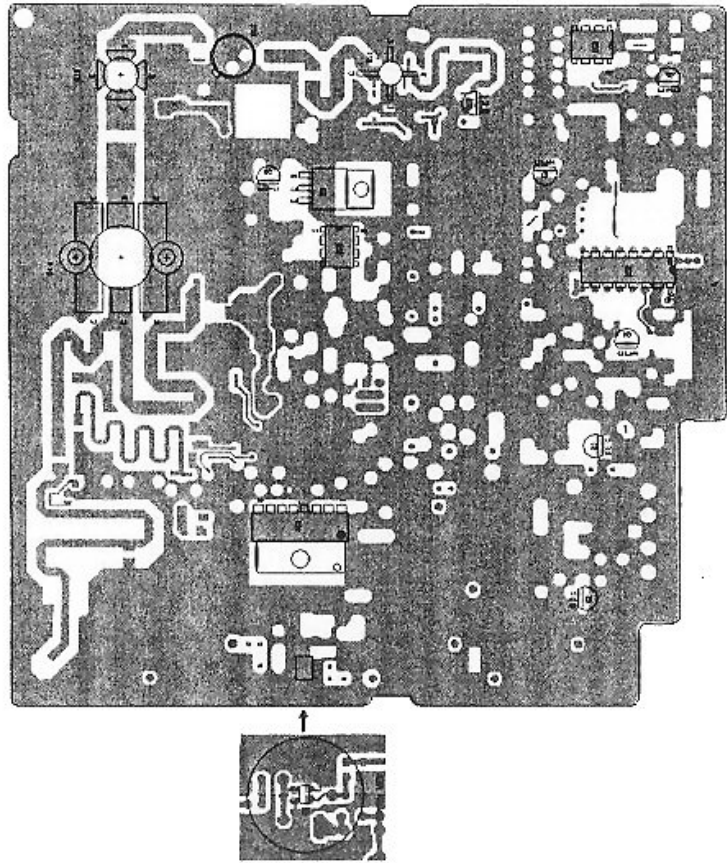

MAXON SM-4450 UHF SYNTHESIZED MOBILE
VOLTAGE CHART-DIGITAL PCB

IC101

NO	RX	TX
1	13.7	13.0
2	0	0
3	0	5

IC106

NO	RX	TX
1	0	0
2	0	0
3	0	0
4	4.5	4.5
5	5	5
6	5	5
7	4.7	4.7
8	0	0
9	5	5
10	5	5
11	5	5
12	4.6	4.6
13	5	5
14	5	5
15	4.9	4.9
16	5	5

IC108

NO	RX	TX
1	0	0
2	0	0
3	0	0
4	5	5
5	0	0
6	5	5
7	0	0
8	5	5

IC102

NO	RX	TX
1	13.7	13.0
2	0	0
3	0	0
4	8.7	8.7

IC107

NO	UNSQ	SQ	RX	TX
1	0	0	0	0
2	5	5	5	5
3	5	5	5	5
4	5	5	5	5
5	5	5	5	5
6	5	5	5	5
7	0	0	0	0
8	0	0	0	0
9	0	0	0	0
10	0.1	0.1	0.1	0.1
11	0.1	0.1	0.1	0.1
12	0.1	0.1	0.1	0.1
13	4.9	4.9	4.9	4.9
14	0	0	0	0
15	0	0	0	0
16	0	0	0	0
17	4.9	4.9	0	0
18	2.6	2.6	2.6	2.5
19	2.5	2.5	0	0
20	0	0	0	0
21	0	0	0	0
22	0	0	0	0
23	0	0	0	0
24	0	0	0	0
25	0	0	0	0
26	0	0	0	0
27	4.9	4.9	4.9	4.9
28	0	0	0	0
29	4.9	4.9	1.6	1.6
30	1.6	1.6	1.6	1.6
31	5	5	5	5
32	5	5	5	5
33	4.7	4.7	4.7	4.7
34	4.6	4.6	4.6	4.6
35	4.5	4.5	4.5	4.5
36	1.7	1.7	1.7	1.7
37	4.2	4.2	4.2	4.2
38	0	0	0	0
39	0	0	0	0
40	0	0	0	0

IC103

NO	RX	TX
1	1.4	1.4
2	0.8	0.8
3	0	0
4	6.4	6.1
5	13.7	13.1

IC104

NO	RX	TX
1	0	0
2	4.0	4.0
3	4.4	4.4
4	0	0
5	0	0
6	5	5
7	0	0
8	3.8	3.8
9	5.0	5.0
10	3.3	3.3
11	3.0	3.0
12	3.9	3.9
13	0	0
14	4.6	4.6
15	25.3	25.3
16	0	0
17	4.0	4.0
18	4.0	25.2

IC105

NO	RX	TX
1	0.6	0.6
2	5.4	5.4
3	5.4	5.4
4	4.5	4.5
5	0	0
6	5	5
7	0	0
8	8.2	8.2
9	8.6	8.2
10	5.5	5.5
11	8.2	8.7
12	5.4	4.5
13	0	0
14	4.7	4.7
15	15.3	15.3
16	1.8	0
17	5.8	5.8
18	5.8	15.2

IC109

NO	RX	TX
1	0	1.6
2	5.0	5.0
3	0.1	0.1
4	0.1	0
5	0.1	5.0
6	5.0	5.0
7	0	0
8	0	0
9	1.0	0.7
10	1.9	1.9
11	1.8	1.8
12	1.9	0.6
13	1.9	1.8
14	1.0	0.7
15	5.0	5.0
16	5.0	5.0

IC114

NO	RX	TX
1	4.5	2.9
2	4.5	2.8
3	0.1	2.8
4	0	0
5	0.7	0.7
6	2.8	2.8
7	2.8	2.8
8	5.0	5.0

IC119

NO	RX	TX
1	5	5
2	0	0
3	2.6	2.4
4	0	0
5	0.7	0.7
6	0	0
7	0	5.0
8	0	0
9	0	0
10	0	0
11	6.0	6.0
12	8.5	8.6
13	5	5
14	0	0
15	0	0
16	8.7	8.7

Q109

NO	RX	TX
C	4.99	4.99
B	0.02	0.02
E	0	0

Q110

NO	RX	TX
C	0.04	1.4
B	0.64	0.06
E	0	0

Q115

NO	RX	TX
C	0.01	0.0
B	0.66	0.66
E	0.0	0.0

Q112

NO	RX	TX
C	3.38	3.38
B	5.1	5.1
E	5.84	5.84

Q117

NO	RX	TX
C	7.6	7.6
B	1.8	1.8
E	1.27	1.27

Q104

NO	RX	TX
E	0	0
B	0.12	0.12
C	12.9	12.3

Q106

NO	RX	TX
E	5.0	5.0
B	5.0	5.0
C	0	0

Q107

NO	RX	TX
E	5.0	5.0
B	4.31	4.31
C	5.0	5.0

Q108

NO	RX	TX
C	0	0
B	0.64	0.64
E	0	0

Q113

NO	RX	TX
1	2.8	2.8
2	2.8	2.8
3	2.8	2.8
4	0	0
5	2.8	2.8
6	2.8	2.8
7	2.8	2.8
8	5.0	5.0

Q118

NO	RX	TX
E	5.0	5.0
B	5.0	5.0
C	0	0

Q119

NO	RX	TX
E	5.0	5.0
B	4.31	4.31
C	5.0	5.0

Q120

NO	RX	TX
1	8.7	8.7
2	8.7	8.7
3	8.7	8.7
4	8.7	8.7
5	1.5	1.5
6	7.8	8.6
7	0	0
8	4.1	4.1
9	8.7	8.7
10	4.1	4.1
11	0	8.6
12	8.6	8.6
13	0	0
14	0	1.4
15	0	0
16	0	0
17	4.9	4.9
18	4.3	4.3
19	4.1	4.1
20	8.7	8.7

Q121

NO	RX	TX
C	3.38	3.38
B	5.1	5.1
E	5.84	5.84

Q122

NO	RX	TX
E	0	0
B	0.12	0.12
C	12.9	12.3

Q123

NO	RX	TX
E	0	0
B	0.12	0.12
C	12.9	12.3

Q124

NO	RX	TX
E	0	0
B	0.12	0.12
C	12.9	12.3

Q125

NO	RX	TX
E	0	0
B	0.12	0.12
C	12.9	12.3

Q126

NO	RX	TX
E	0	0
B	0.12	0.12
C	12.9	12.3

Q127

NO	RX	TX
E	0	0
B	0.12	0.12
C	12.9	12.3

Q128

NO	RX	TX
E	0	0
B	0.12	0.12
C	12.9	12.3

Q129

NO	RX	TX
E	0	0
B	0.12	0.12
C	12.9	12.3

Q130

NO	RX	TX
E	0	0
B	0.12	0.12
C	12.9	12.3

Q131

NO	RX	TX
E	0	0
B	0.12	0.12
C	12.9	12.3

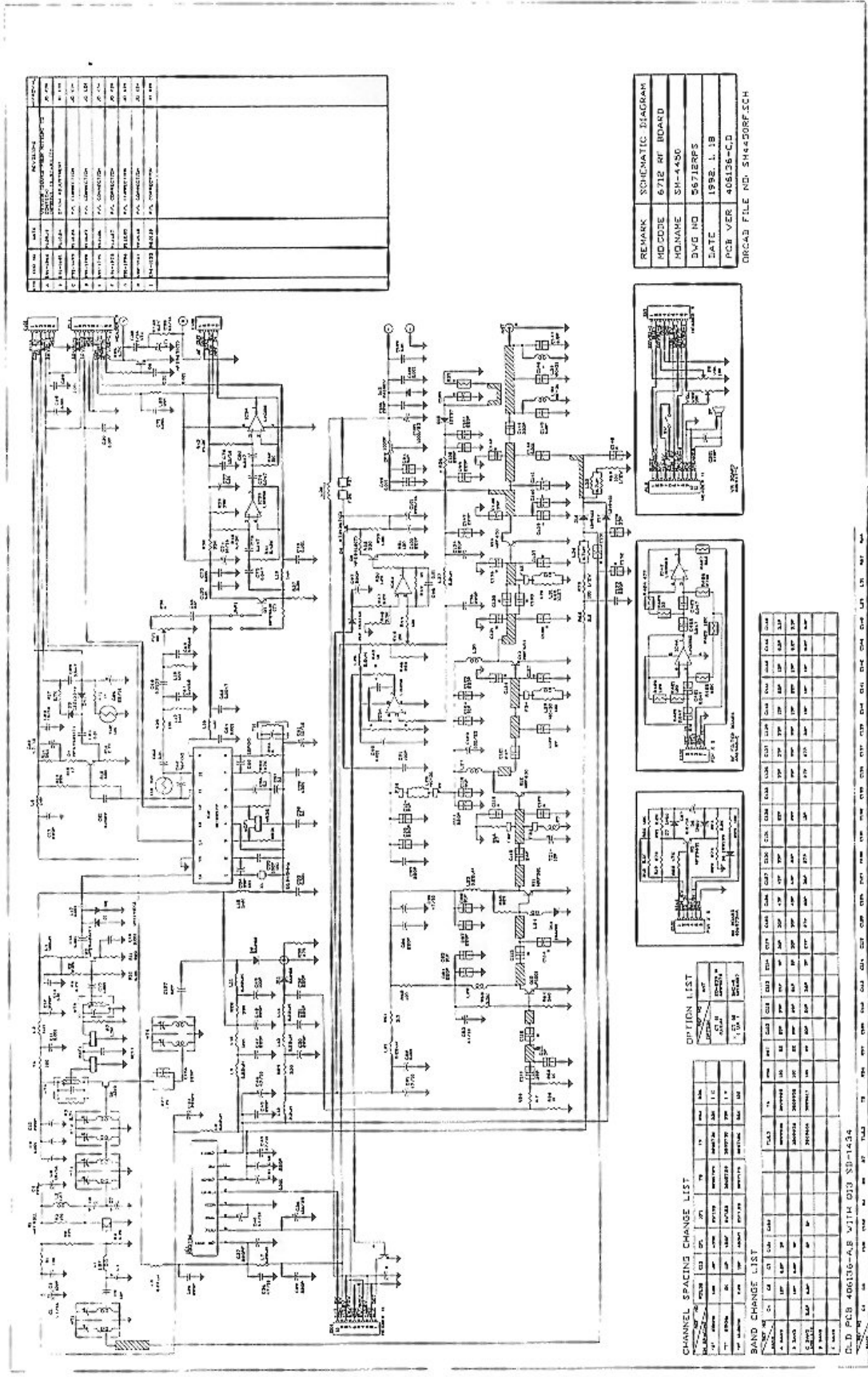

REV	DATE	DESCRIPTION
1	1982.1.19	INITIAL DESIGN
2	1982.1.19	REVISED FOR MANUFACTURE
3	1982.1.19	REVISED FOR MANUFACTURE
4	1982.1.19	REVISED FOR MANUFACTURE
5	1982.1.19	REVISED FOR MANUFACTURE
6	1982.1.19	REVISED FOR MANUFACTURE
7	1982.1.19	REVISED FOR MANUFACTURE
8	1982.1.19	REVISED FOR MANUFACTURE
9	1982.1.19	REVISED FOR MANUFACTURE
10	1982.1.19	REVISED FOR MANUFACTURE

REMARK	SCHEMATIC DIAGRAM
NO CODE	6718 RF BOARD
NO NAME	SM-4450
DWG NO	56718RFS
DATE	1982.1.19
PCB VER	408138-C-D
ORCAD FILE NO. 5H4450RF.SCH	

CHANNEL SPACING CHANGE LIST

CH	OLD	NEW	REASON
1	100	100	
2	100	100	
3	100	100	
4	100	100	
5	100	100	
6	100	100	
7	100	100	
8	100	100	
9	100	100	
10	100	100	

OPTION LIST

OPT	DESCRIPTION	VALUE
1	OPTION 1	100
2	OPTION 2	100
3	OPTION 3	100
4	OPTION 4	100
5	OPTION 5	100
6	OPTION 6	100
7	OPTION 7	100
8	OPTION 8	100
9	OPTION 9	100
10	OPTION 10	100

BAND CHANGE LIST

BAND	OLD	NEW	REASON
1	100	100	
2	100	100	
3	100	100	
4	100	100	
5	100	100	
6	100	100	
7	100	100	
8	100	100	
9	100	100	
10	100	100	

OLD PCB 406136-AS WITH 012 SD-1434

