

---

---

# maxon<sup>®</sup>

---

---

## SP-130/140 Series Synthesized Scanning Radio

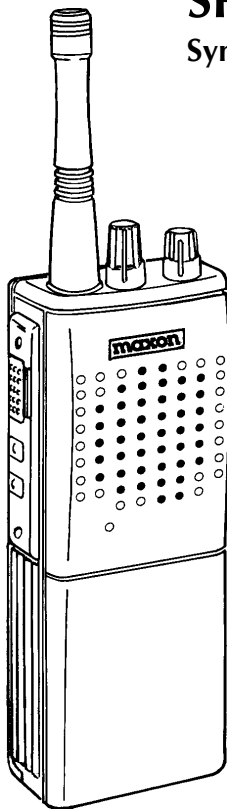

**Operating  
Instructions**

## **About Your SP-130/140 Series Radio**

---

Maxon's SP-130/140 Series radios feature 4/16 channel operation with superior performance and reliability. Operation and functions for Maxon's SP-130/140 Series radios are described in this manual.

**We urge you to thoroughly read this manual before operating the radio.**

Application of some of the functions described in this manual is determined by the system you use. Your Maxon Dealer will program your radio so that you have the greatest number of functions possible relative to your needs.

Should you have questions regarding the operation of the radio, please consult your Maxon Dealer.

## **About Maxon America, Inc.**

---

Maxon America, Inc. designs and manufactures professional FM two-way radio equipment to serve a wide variety of communication needs. Maxon produces equipment for the Land Mobile Radio and Specialized Mobile Radio markets (business, industrial, government and public safety).

## Table of Contents

---

Safety Information.....	2
Unpacking Information.....	3
SP-130/140 Series Features.....	4
Description of Radio Components.....	5
Antenna Installation.....	7
Installing and Removing the Battery Pack .....	7
Attaching and Removing the Belt Clip.....	7
Battery Charging and Care.....	8
SP-130/140 Series Operation.....	9
Power On-Volume.....	9
Transmit.....	9
Receive.....	9
Power Off.....	10
Status Indicators and Audible Alert Tones.....	10
Scan Modes.....	11
Normal Channel Scan.....	11
Priority Channel Scan.....	11
Other Scanning Features.....	12
Look Back.....	12
Scan Channel Delete.....	12
CTCSS/DCS Scanning.....	12
Normal Scan TX.....	12
Priority Scan TX.....	12
Priority Only TX.....	12
Receive Only Scan.....	12
Licensing and Service Information.....	13
Recycling/Disposal of Batteries.....	13
Software Copyrights.....	14
Maintenance.....	15
Warranty Statement.....	16

## Safety Information

---

The Federal Communications Commission (FCC), with its action in General Docket 79-144, March 13, 1985, has adopted a safety standard for human exposure to Radio Frequency (RF) electromagnetic energy emitted by FCC regulated equipment. Maxon subscribes to the same safety standard for the use of its products. Proper operation of this radio will result in user exposure far below the Occupational Safety and Health Act and Federal Communications Commission limits.

**WARNING - DO NOT** hold the radio in such a manner that the antenna is next to, or touching, exposed parts of the body, especially the face or eyes, while transmitting.

**WARNING -DO NOT** allow children to operate transmitter - equipped radio equipment.

**CAUTION - DO NOT** operate the radio near unshielded electrical blasting caps or in an explosive atmosphere unless it is a type especially designed and qualified for such use.

**CAUTION - DO NOT** press and hold the transmit switch (P-T-T) when not actually wishing to transmit.

**NOTE: This radio operates in FCC regulated frequency bands. All radios must be licensed by the FCC before use. Because this radio contains a transmitter, Federal law prohibits unauthorized use or adjustments of this sradio.**

## Unpacking Information

---

Remove and carefully inspect the contents of your package(s) for the following items:

- Radio
- Battery Pack
- Antenna
- Spring Belt Clip
- Operating Instructions

If any items are missing, please contact your Dealer or Maxon.

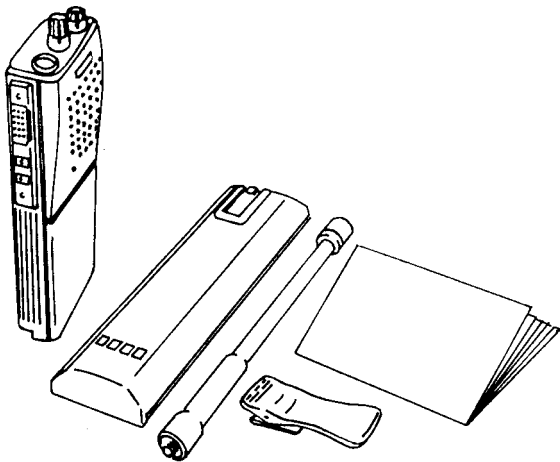

## **SP-130/140 Series Features**

---

- Wideband frequency separation
- 1/5 Watts programmable output power
- Programmable 12.5/25 kHz channel spacing
- Channel scan
- Priority channel scan
- Look back channel
- CTCSS/DCS tone signalling
- Busy channel lockout
- Time-out timer

## **Description of Radio Components**

---

- 1) Antenna Receptacle**
- 2) Channel Selector Knob**
- 3) On/Off - Volume Control**
- 4) Busy/TX/BT Indicator**
- 5) Battery Latch**
- 6) Push-To-Talk (PTT)**
- 7) Monitor Button**
- 8) Option Button**
- 9) Speaker**
- 10) Microphone**
- 11) Accessory Connector**
- 12) Belt Clip**
- 13) Battery**
- 14) Battery Charge Contacts**

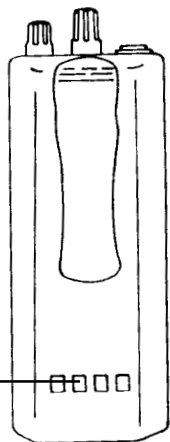
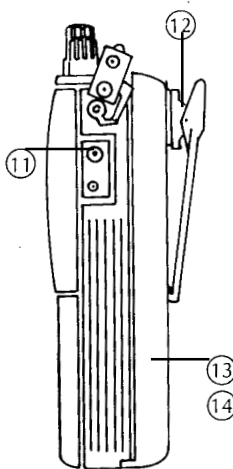
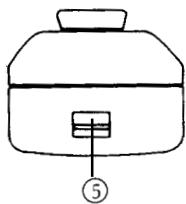
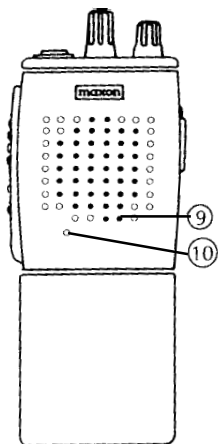
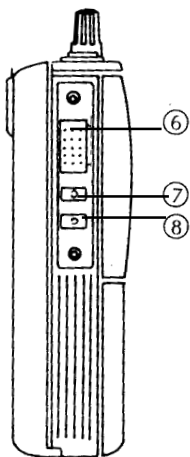
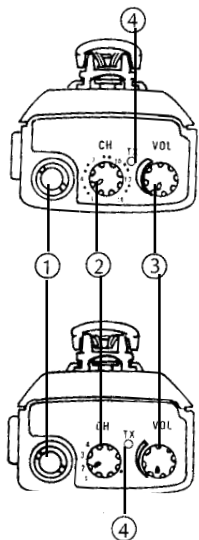



## Antenna Installation

---

Fasten the antenna to the radio by turning the antenna clockwise into the receptacle on top of the radio.

## Installing and Removing the Battery Pack

---

### To Install:

Position the guides of the battery in line with the radio battery guide rails and slide the battery into position until a click is heard.

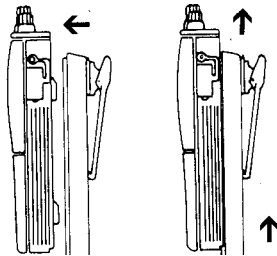

### To Remove:

Holding radio in one hand, slide and hold battery latch. With the other hand, push the battery in downward direction.

## Attaching and Removing the Belt Clip

---

### To Install:

Install belt clip on back of battery until it clicks into place.

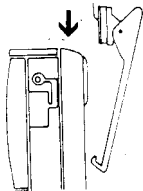

### To Remove:

Pull release tab outward and push belt clip up.

## **Battery Charging and Care**

---

To ensure peak performance from your radio, the battery pack must be fully charged. Proper care and charging will allow maximum performance and life of your battery pack.

The optional QPA-1135 Pedestal Charger provides a slow overnight charge of 12-16 hours.

The optional QPA-1125 Desktop Charger provides 1.5 hours charging and normal "slow" charging to one radio and one battery.

See accompanying instructions included with these chargers for more information.

To receive maximum performance from your radio and battery pack, periodically completely discharge and recharge the battery pack.

## SP-130/140 Series Operations

---

### Power On-Volume

Turn the radio on by rotating the on/off - volume control clockwise until you hear a click and the self test "alert" tone.

### Transmit

<p style="text-align: center;"><b>CAUTION</b> <b>OPERATION OF THE TRANSMITTER WITHOUT A PROPER ANTENNA INSTALLED MAY RESULT IN PERMANENT DAMAGE TO THE RADIO</b></p>
--

1) Press the monitor button to monitor the channel for activity. To avoid interrupting another user, make sure the channel is clear before you begin transmitting.

**NOTE:** Federal Communications Commission Rules and Regulations require that you monitor a channel for activity before transmitting.

**NOTE:** The tri-color LED located on the top panel can help with channel monitoring. It will glow amber if RF activity is present; or green if the transmission has a CTCSS or DCS tone that matches a tone programmed for receive in your radio. When this LED is not illuminated, the radio is indicating a "clear" channel.

2) When the channel is clear, hold the radio upright with the antenna vertical and the front microphone area about 2-3 inches from the mouth, keeping the antenna away from the face and eyes. Press and hold the P-T-T bar on the side of the radio, and speak slowly and clearly into the microphone area.

**NOTE:** The LED will glow red when transmitting. This indicator should be on continuously while the P-T-T bar is being pressed and the radio is transmitting. Should the red LED be "flashing", the battery needs to be recharged and transmission will cease. Recharge the battery before attempting more than one transmission.

### Receive

When you have finished transmitting, release the P-T-T bar to receive.

## Power Off

When finished transmitting, receiving, monitoring, etc., turn the radio off by rotating the on/off-volume control fully counter-clockwise, to the detent position.

## Status Indicators and Audible Alert Tones

---

Your SP-130/140 Series has a sophisticated microprocessor control which provides a series of audible alert tones.

Upon initial power up, a quick melody indicates that the self-test of the microprocessor functions has been completed satisfactorily. A series of tones may be sounded with any of the following conditions:

- Attempt to transmit on a channel set for receive only
- Attempt to transmit on a channel that is already in use when busy channel lockout has been programmed into the radio \*
- Transmitting time has exceeded time-out timer programmed length \*
- Low battery condition
- Selecting a channel with no programmed frequency

\* Indicates a function that is initially programmed into the radio by your Maxon Dealer.

**NOTE: All audible tones can be programmed off for silent operation.**

STATUS	DESCRIPTION	LED COLOR	AUDIBLE TONE
NORMAL	Power On - Ready	N/A	Melody
	Busy	Amber	N/A
	Correct Call	Green	N/A
	Transmit	Red	N/A
	Busy Lock	Amber, Flashing	Single Tone
IN SCAN	Scan is initiated	Green, Flashing	N/A
WARNING	Time-Out Timer	N/A	Single Tone
	Battery Low	Red, Flashing	Four Tone, Repeated
ERROR	EEPROM Error	Red, Flashing	Single Tone, Repeated
	PLL Error	Red, Flashing	Double Tone, Repeated
	Filtering Error	Red, Flashing	Three Tone, Repeated

## Scan Modes

---

Scanning is a Dealer programmable feature that allows you to monitor a number of channels. Your Dealer will help you define a channel "scan list" to be programmed into a scan channel (any channel, 1-4 on model SP-130) or (any channel, 1-16 on model SP-140). Once that channel location is selected, scan is initiated.

### **Normal Channel Scan**

Once the scan list is programmed you can initiate scan. Simply move the channel selector knob to the scan channel position and the radio will start to scan. The top panel LED can be programmed to flash green as the radio is scanning.

If a conversation is detected on any of the channels in the scan list, the radio will stop on that channel and you will be able to hear the conversation. If programmed for normal scan TX you will be able to transmit on that active channel during the programmable scan delay time. The scan delay time is the amount of time the radio will stay on that channel once activity has ceased (Dealer programmable, 4-7 seconds is typical). The radio will resume scanning once the scan delay time has expired. Scanning will continue until the channel is changed.

### **Priority Channel Scan**

A single channel may be programmed as the "Priority" channel. The radio will constantly monitor this channel while scanning and when the radio has stopped on an active channel. If a call is detected on the "Priority" channel, the radio will automatically move to, and remain on, the "Priority" channel for as long as the priority conversation takes place. "Priority" channel activity takes precedence over all other conversations.

**NOTE:** "Priority" channel scan and "look back" require that the radio leave the active channel for a fraction of a second (at regular intervals) to check the priority channel for a message. Depending upon how the radio is programmed (scan speed, etc.) this may or may not be noticeable as "breaks" on the active channel for that same fraction of a second.

## Other Scanning Features

---

- **Look Back:** Any channel, when not in the scan mode, can be programmed to "look back" at the "Priority" channel. This feature is ideal for those who do not need scan as defined above, but want to make sure that they never miss a call on the "Priority" channel if another channel has been selected. Once a "look back" channel has been selected, the radio will periodically "look back" at the "Priority" channel. If activity is detected on the "Priority" channel, the radio will move to that channel for as long as it remains active.
- **Scan Channel Delete:** To temporarily delete a channel from the scan list, simply press the monitor button while scanning and stop on the channel to be deleted. This will remove that channel from the scan list until the channel is changed or the radio's power is reset. When power is restored or the scan list channel position is again selected, the original Dealer programmed scan list will be activated.
- **CTCSS/DCS Scanning:** The SP-130/140 can be programmed by your Dealer to scan for tone. This will help block out unwanted calls.
- **Normal Scan TX:** Allows a transmission only after a call is received, depending on the programmed scan delay time. After the scan resumes, and a transmission is made, the radio will sound an alarm (two beeps) and will not allow a transmission.
- **Priority Scan TX:** Allows a transmission after a call is received depending on programmed scan delay time. The transmission will be made on the channel that the call was received. After the scan resumes, if a transmission is made, the radio will transmit on the programmed priority channel.
- **Priority Only TX:** Allows a transmission on the priority channel when scanning and not stopped on an active channel. It can also be programmed to always transmit on the priority channel if scanning or stopped on an active channel.
- **Receive Only Scan:** This allows only reception. If a transmission is made at any time, the radio will sound an alarm (two beeps) and will not allow the transmission.

## Licensing and Service Information

---

### FCC Licensing

The Federal Communications Commission requires that the operator of this radio be properly licensed under the applicable Part and/or Parts of the FCC Rules and Regulations.

Consult with your Maxon Dealer, or contact the nearest FCC Field Office for information about obtaining a license.

### Service

Do not tamper with internal adjustments. Damage to the equipment and/or improper operation may result. There are no user serviceable items inside the radio.

It is recommended that you return your radio to a qualified Maxon Dealer for any service or repairs.

## Recycling/Disposal of Batteries

---

The U.S. Environmental Protection Agency (EPA) classifies used Ni-Cd batteries as hazardous waste, unless certain exemptions apply.

The battery should be recycled at the end of its useful life. Under various state or local laws, such batteries must be recycled or disposed of properly and cannot be dumped in landfills or incinerators.

Maxon America, Inc. fully endorses and encourages the recycling of Ni-Cd batteries. A national program to collect and recycle used Ni-Cd batteries is being implemented by the Rechargeable Battery Recycling Corporation (RBRC™). This program is being funded through the use of license fees paid by the battery and product manufacturers to place the RBRC™ Seal on the batteries.

The following is a list of facilities where the batteries can be shipped to be recycled. Contact these facilities for proper packaging and shipping guidelines.

**INMETCO**  
245 Portersville Road  
Ellwood City, PA 16117  
TEL: (412) 758-2800  
FAX: (412) 758-2842

**Kinsbursky Brothers Inc.**  
1314 N. Lemon Street  
Anaheim, CA. 92801  
TEL: (714) 738-8516  
FAX: (714) 441-0857  
(800)-548-8797

## Software Copyrights

---

The Maxon products described in this operating instruction manual may include copyrighted Maxon software programs stored in semiconductor memories or other media. Laws in the United States and other countries preserve for Maxon certain exclusive rights for copyrighted software programs, including the exclusive right to copy or reproduce in any form the copyrighted software program. Accordingly, the copyrighted Maxon software programs contained in the Maxon products described in this operating instruction manual may not be copied or reproduced without the express written permission of Maxon. Furthermore, the purchase of Maxon products shall not be deemed to grant either directly or by implication, estoppel, or otherwise, any license under the copyrights, patents or patent applications of Maxon, except for normal non-exclusive royalty free license to use that arises by operation of law in the sale of a product.



## Maintenance

---

Your SP-130/140 Series Radio is designed to be maintenance free. To keep your radio in good working condition:

Clean external surfaces with a clean cloth dampened in a solution of dishwasher detergent diluted in water. Apply the solution sparingly to avoid any moisture leaking into cracks and crevices. Do not submerge the radio. Use a non-metallic brush to dislodge stubborn particles, if necessary. Dry the surface thoroughly with a soft, lint free cloth.

**DO NOT** use solvents or spirits for cleaning - they may permanently damage the housing.

Clean the battery contacts on the back of the radio with a lint free cloth to remove dirt, grease, or other foreign material that may impede good electrical contact.

## Limited Warranty

---

Maxon America, Inc. ("Maxon") warrants the Maxon Product manufactured by it against defects in material and workmanship under normal use and service for a period of two (2) years from the date of delivery to the original end user, provided that the user has complied with the requirements stated herein. This warranty is not assignable or transferable. Maxon is not responsible for any ancillary equipment which is attached or used in connection with this product.

Maxon shall have no obligation to make repairs or to cause replacement required which result from normal wear and tear or necessitated in whole or in part by catastrophe, fault or negligence of the user, improper or unauthorized alterations, repairs to the Product, use of the Product in a manner for which it was not designed, or by causes external to the Product. This warranty is void if the serial number is altered, defaced or removed.

Maxon's sole obligation hereunder shall be to repair or replace the Product covered in the above warranty.

To receive warranty service, deliver or send the Product, transportation and insurance prepaid, to the place of purchase along with your proof of purchase. Alternatively, call 1-800-821-7848 for other locations or authorization to return the product directly to Maxon.

**THE EXPRESS WARRANTIES CONTAINED HEREIN ARE IN LIEU OF ALL OTHER WARRANTIES, EITHER EXPRESSED OR IMPLIED OR STATUTORY, INCLUDING, WITHOUT LIMITATION, ANY WARRANTY OF MERCHANTABILITY OR FITNESS FOR A PARTICULAR PURPOSE.**

**FOR ANY PRODUCT WHICH DOES NOT COMPLY WITH THE WARRANTY SPECIFIED, THE SOLE REMEDY WILL BE REPAIR OR REPLACEMENT. IN NO EVENT WILL MAXON BE LIABLE TO THE BUYER OR ITS CUSTOMERS FOR ANY DAMAGES, INCLUDING ANY SPECIAL, INCIDENTAL, INDIRECT OR CONSEQUENTIAL DAMAGES, OR FOR THE LOSS OF PROFIT, REVENUE OR DATA ARISING OUT OF THE USE OF OR THE INABILITY TO USE THE PRODUCT.**

This warranty is void for sales and deliveries outside of the United States.

**maxon**<sup>®</sup>

*A World of Communications*

**Maxon America, Inc.**

**Business Radio Division**

10828 NW Air World Drive

Kansas City, Missouri 64153

816/891-6320, Ext. 399, FAX: 816/891-8815