



**MOTOROLA**

**GP68**



## Operation Guide

**A High Performance Radio  
In A Class Of Its Own**

### Key Features:

- Wide Frequency Bands
- Adaptive Power Control™
- PL/DPL Coded Squelch Operation
- SmarTrunk II Upgrade
- Radius Port™ Expendability
- Passed MIL STD 810E
- Voice Selective Call (option)

### Basic Features:

- Front Panel Programming
- Telephone Interconnect
- Radio-To-Radio Cloning
- Repeater Operation
- Selectable High/Low Power
- Selectable Time-Out Timer
- Low Battery Alert Indicator
- Battery Saver
- DTMF Dialing, 9 Number Memory
- Keypad Lock
- Receive signal strength indicator
- Passed Motorola's Accelerated Life Testing

### Frequency Range:

- VHF 136-174MHz
- UHF 430-470MHz

### RF Output:

- VHF 5W or 1W
- UHF 4W or 1W



**Turn Radio On**

1. Rotate rotary knob clockwise to turn radio on.



**Turn Radio Off**

1. Rotate rotary knob counter-clockwise until a click is heard to turn radio off.

**Adjust Volume**

1. If there is no receive audio, press end hold the Monitor Button until you hear background noise.
2. Continue to hold the Monitor Button and adjust rotary Knob for desired volume level.
3. Release the Monitor Button to squelch radio again.



**To Select a Channel**

1. Rotate the selector switch clockwise to increase or counter-clockwise to decrease, the channel number.



The channel number increments, or decrements according to the available programmed memory channels (i.e. empty channels are NOT displayed).

**Locking/Unlocking the Keypad**



1. Press and hold  (Lock) to lock (or unlock) the keypad and selector switch (takes about 2 seconds).

2. If you attempt to press a key other than  (Lock) or rotate the selector switch while the keypad is locked, the LCD displays and no action is taken.

**High/Low Power Output**

1. Press  (LOW/C) to toggle between High and Low power output levels.



The LOW Indicator is on when the radio is set for Low power output mode and off when the radio is set for High power output mode.



## Low Battery Alert

The “**BATT**” indicator in the LCD continuously flashes whenever the radio has a low battery condition (in receive or transmit mode).

A low battery condition is also indicated by three low-pitched beeps, repeated every two minutes.



## Display Backlight

The LCD has a backlight which is activated when the Toggle Light/Enter Button is pressed. The LCD backlight turns off 5 seconds after the last user activity or, if Toggle Light/Enter Button is pressed, the backlight turns off immediately (pressing Toggle Light/ Enter Button will always toggle the status of the backlight).

## PTT ID

If programmed, the radio transmits a DTMF identification code (unit ID), indicating which portable is in operation.

During a conversation, the code is normally sent only on the initial PTT press (unless PTT ID has been disabled). The 'TX' indicator lights for the duration of the PTT ID. If there is no PTT or receive activity for 7 seconds, or if you change the channel (or scan resumes), the PTT ID is once again transmitted on the next PTT press.

**NOTE:** PTT ID can be enabled/disabled by pressing and holding  (#). Upon pressing the button you will hear a beep; hold the button down until you hear a second beep, indicating that the PTT ID status has been changed, then release the button. When PTT ID is disabled the 'dot' indicator flashes on the display.

## To Transmit

1. Depending on the mode of operation, select the desired channel (refer to the next section for details on selecting a channel).

2. Do not interrupt another user. If the selected Channel is programmed to receive PL, press and hold the Monitor Button to enter monitor mode and listen for channel activity. The channel must be clear before transmitting.

3. Press PTT.

The "Tx" indicator lights up whenever radio transmits, and goes off when PTT is released.

4. Hold radio upright while speaking clearly into the microphone.



## To Receive

1. Release PTT to hear voice activity on selected channel.



## To Change Squelch Modes

Carrier squelch (CSQ), Tone Private-Line (PL) and Digital Private-Line (DPL) operations are available on a per channel basis. As an option, Signaling squelch (SelCall) operation is available on a per channel basis.

You can override the default receive squelch mode for the channel temporarily.



## To override squelch mode:

1. Press to change between CSQ, Coded (PL/DPL) and Signaling squelch modes.



## To Set Squelch Level

1. Press  (SQL/B) to enter the squelch edit mode.

The squelch is displayed in the range '00' (open squelch) to '15' (tight squelch). In the following example, the squelch level is '02':



2. Rotate the selector switch clockwise to increase, or counter clockwise to decrease the displayed squelch level.
3. Press the Toggle Light/ Enter Button momentarily (or any other button) to adopt the selected squelch level and return to normal operating mode (the radio automatically does this after 5 seconds of inactivity).

The new squelch level is adopted.

When 'CTCSS' is off, the radio operates in CSQ mode.

When "CTCSS" is on continuously, the radio operates in Coded (PL/DPL) squelch mode.

When "CTCSS" is flashing (which requires an optional Selective Call board), the radio operates in Signaling squelch mode, and unmutes only after a valid Voice Selective Call (SelCall) has been decoded.



When programmed to do so, your GP-68 will quickly SCAN the channels you want it to.

### To Scan Channels

1. Press  (SCAN/D) momentarily to begin channel scanning.



When the 'SCAN' indicator flashes, channel scanning is in progress and the 'Home' channel is displayed (until activity is received on another channel).

2. Initially, the channels are scanned in an increasing order (from lowest to highest). To scan in a decreasing order, rotate the selector switch counter-clockwise. To change the direction back to an increasing order, rotate the selector switch clockwise.



The radio scans through all channels that are in the scan list. If receive activity is detected on a channel, the 'SCAN' indicator remains on, the channel number is displayed, and the conversation can be heard, provided the PL/DPL code (if required) is correct for that channel.

The display reverts to the 'Home' channel and scanning resumes when activity is over and a 7 second 'hang time' has expired.

3. To stop scan operation, press  (SCAN/D) momentarily.

The 'SCAN' indicator turns off to indicate scanning is terminated and the radio displays the 'Home' channel.

### To Transmit During Scanning

1. When keying the radio corresponding to a received message during channel scanning, press PTT as you normally would.

### Talk Back Scan

The Talk Back Scan feature is used when PTT is pressed while the radio has stopped on a channel. When transmit or receive activity ceases on a scanned channel, a "hang time" of approximately 7 seconds occurs prior to the radio resuming scan. This hang time gives the radio time to receive again or gives you time to respond to a call on the locked channel before scanning resumes.

### Home Revert Scan

If you press PTT while the radio is scanning (i.e. the scanner is not locked on any channel), transmission occurs on the "Home" channel (i.e. the channel that was active when the scan operation was initiated). After Home transmit and receive activity ceases, the radio resumes channel scanning after the hang time has expired.

## **Nuisance Channel Delete in Scan**

When the radio scans to a channel that you do not wish to hear, you can temporarily remove the channel from the scan list using the Nuisance Channel Delete feature.

1. With the scanner locked on the unwanted signal, press and hold  (SCAN/D) for about 2 seconds.
2. To add a deleted channel back into the scan list, you must exit and reenter the scan function or turn the radio off and on.

## **Special Scan Mode - Search Mode**

There is a Frequency Search Function that is *not* mentioned in any Motorola manual printings.

By using the normal style of programming mentioned below you may search through a range of frequencies between a start and stop frequency like a scanner.

1. Program a start frequency (normally the lower limit) into channel 19.
2. Program a stop frequency (normally the upper limit) into channel 20.
3. By remaining in the Frequency Display Mode at either the start or stop frequency you have chosen, press the scan button. The GP68 will search between those two limits until a signal is received.

As with the other 18 channels the Frequency Step Size can be set, i.e. 5, 10, 12.5, 20, or 25KHz. This should be based on the channel spacing Band Plan for the service and segment of frequencies you wish to search.

You will only be able to do one of these functions at a time.

Note: By going into the SPM Mode (Discussed elsewhere in this document) It would be wise to delete these 2 channels from the normal channel scan list - by doing this you will speed up your normal channel scan mode.

## **Temporary Keyboard Lock Procedure**

With your radio in the on position one may temporarily lock the keyboard.

1. Press and hold the star/lock icon key until "F.Loc" shows on your LCD display.

By doing this you will be able to lock the keyboard only - thus preventing normal handling from inadvertently changing key/critical parameters. None of the critical functions such as changing channels, scan function, and hi/low power switching are affected by the keyboard lock and are still enabled. Once you turn the radio off the above keypad lock is defeated.

**Dealer Program Mode (DPM) - To Enter Dealer Programming Mode**

1. Switch Radio Off.
2. Hold Down the PTT Monitor and Scan Buttons While Turning the Radio On.
3. Proceed to Program Radio. When programming is complete...

**To Exit Dealer Programming Mode**

1. Switch Radio Off.
2. Hold Down the PTT, Monitor and Enter Buttons While Turning the Radio On. (Secure Keyboard Lock Procedure) This will protect all of your critical programmed parameters from being tampered with.

**Note:** When the GP68 is in programming mode it will not transmit or receive until you exit from dealer programming mode.

**Overview of the Programming Process**

The following procedures assume that you have read and understood the basic operation of the GP68 from the GP68 User's Manual. A Dealer's radio is the radio where all the necessary options are programmed into. A User's radio is the radio whose options are cloned from the Dealer's radio; it is this radio that is given to the customer. To enable the programming function in the Dealer's radio, remove jumper R417. If the "dot" between the CH & channel number is flashing, the jumper has already been removed and the radio can be field programmed.

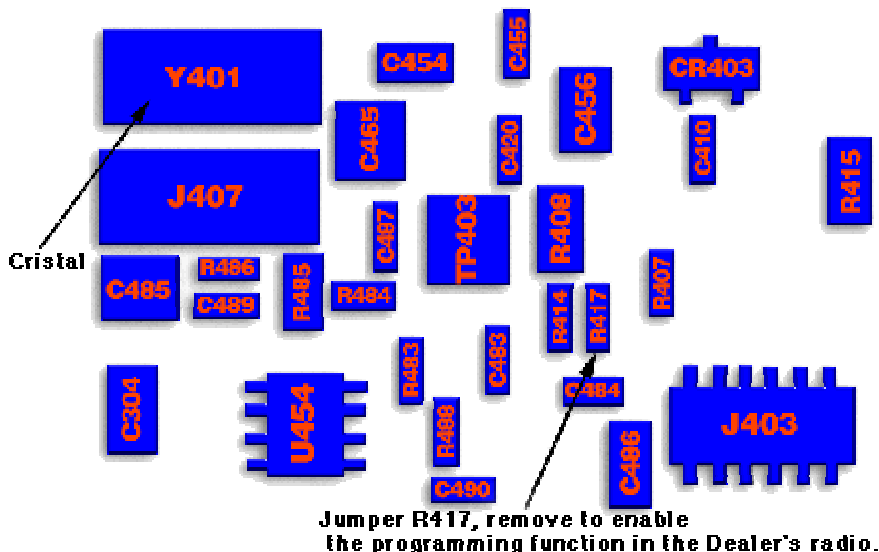

**IMPORTANT**

If the Dealer's radio is to be given to the customer, remember to place R417 with a 51K resistor to disable the programming function.

If you are unable to program the GP-68, either jumper R417 has not been removed, or your dealer has replaced it with a 51K ohm resistor to prevent end-user programming.

**Programming Controls**



"Figure A"

Note that the **ENTER** key is on the side of the GP-68, very near the top.

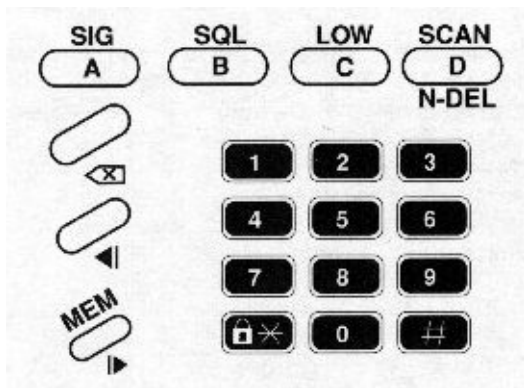

"Figure B"

Along the top/front of the GP-68 there are four buttons labeled: **SIG/A**, **SQL/B**, **LOW/C**, and **SCAN/D - N-DEL**. The three buttons along the left side: **X**, **LEFT ARROW**, and the **MEM/RIGHT ARROW** key. Some keys have multiple functions, depending upon whether they are *quickly* pressed and released or if they are pressed for a *few seconds*, or if using *DTMF tones*:

Key	Quick Press	Long Press	DTMF Dialing
<b>SQL B</b>	Programs Squelch	Program PL/DPL	"B"
<b>LOW C</b>	Toggles Hi/Low Power	Frequency Step Size	"C"
<b>X</b>	Toggles MHz and Ch. Display modes		When editing phone #'s, BACKSPACE.
<b>LEFT</b>	TX offset freq.		When editing phone numbers, scrolls left.



## **Programming Your Channels**

All programming is performed while the GP-68 is in Frequency Display Mode. When you first turn the radio on, the display will show a Channel Number (e.g., "Ch.01"). To enter Frequency Display Mode, press the **X** key.

The GP68 contains 20 memory channels and each channel can store a receive (RX)/Transmit (TX) frequency, the type of offset (plus/minus), offset frequency, RX/TX PL/DPL tone codes, and the default squelch mode. Choose the channel to program with the Channel Selector **BEFORE** starting to program. This way, there is less chance of accidentally erasing the information in a memory location you do not wish to reprogram. Select the channel you want to program, THEN press the **X** key and program.

1. While in **Channel Display Mode**, select the channel to program.
2. Press the **X** key to enter Frequency Display Mode.
3. **ENTER FREQUENCY** using the DTMF keypad. The LCD display will reflect your keystrokes.

NOTE: You only have about five seconds between keypresses, or the unit will revert to the previously-stored information.

If your frequency won't "take," you might need to change the **Frequency Step Size**. You may choose between 5, 10, 12.5, 20, or 25KHz. To change the default step size, press and hold the **LOW/C** key for about three seconds - until the current step size is displayed. Use the Channel Selector knob to choose your desired step size. Then press the **ENTER** button to store it.

4. **SET TX OFFSET** by pressing the **LEFT ARROW** key to toggle between duplex +, -, or NONE (simplex) TX offset.

5. **SET TX and RX PL/DPL TONES:** There are 42 PL (CTCSS) tones and 84 DPL (DCS) tones available. Please see the Motorola's conversion chart to locate the desired tone code, for example, CTCSS "141.3" is "023" in the GP-68.

NOTE: Use the accompanying Motorola Tone Conversion Chart to determine any required PL or DPL tones that may need to be programmed.

While still in Frequency Display Mode, press and hold the **SQL/B** key for about three seconds, until the display shows the "rPL" information (e.g., "rPL.023"). Use the Channel Selector knob to choose your PL/DPL tone for RECEIVE. Of course, if you desire to receive OPEN TONE, leave the "rPL" setting at "000."

Pressing the **SQL/B** key once more gets you to the - the TRANSMIT tone setting ("tPL.xxx"). Use the Channel Selector knob to choose the tone.

Either press any key to "set" these changes, or wait three seconds, and the GP-68 will revert to Frequency Display Mode automatically.

6. Now that you've entered your frequency, set the offset, and entered your tones, **SAVE** all this information by pressing the **ENTER** button for three seconds, until the display prompts you with a "P" before your channel number (e.g., "PCh.01"). If that is, indeed, the channel number in which you want this new information stored, simply press the **ENTER** key once more - momentarily. The new frequency will show in the display, and the radio will remain in Frequency Display mode.

Press the **X** key to return to Channel Mode display.

To verify the frequencies programmed, from the Channel Display mode, press the **X** key to toggle between Channel Display and Frequency Display modes. Rotate the Channel Selector knob to the channel you want to verify, then press and hold the **ENTER** button for three seconds.

You can check out all the settings...then, if **NO** changes were made, simply press the **X** key momentarily to go back to Channel Mode display. If you **DID** make a change or two, you will need to press the **ENTER** key for three seconds again - then again momentarily - as in Step 6 above - to save the changes.

### To Select the Receive PL/DPL Code



"Figure C"

1. Press and hold  (SQL/B) until the LCD displays "rPL" followed by the active Receive PL code number (takes about 3 seconds). In the following example (Figure C), the Receive PL/DPL code is 014 (103.5/1A).





2. Rotate the selector switch clockwise to increase, or counter clockwise to decrease, the active Receive PL/DPL code.

3. Momentarily press any key to immediately adopt the selected Receive PL/DPL code and return to normal operating mode (the radio automatically does this after 3 seconds of inactivity).

The new Receive PL/DPL code is adopted.

### To Select the Transmit PL/DPL Code

1. Press and hold  (SQL/B) until the LCD displays "rPL." followed by the active Receive PL code number (takes about 3 seconds). Press  (SQL/B) momentarily to toggle the display to 'tPL.' followed by the active Transmit PL code number. You can toggle between editing of the Receive and Transmit PL/DPL by pressing  (SQL/B) momentarily. In the following example (Figure D), the Transmit PL/DPL code is 020 (127.3/3A).

**Carrier Squelch (CSQ), Private-Line (PL) and Digital Private-Line (DPL) Codes**



rPL xxx	PL Tone	Equiv.	rDPL xxx	Equiv.	rDPL xxx	Equiv.
tPL xxx	(Hz)	PL Code	tDPL xxx	DPL Code	tDPL xxx	DPL Code
000	CSQ	-	043	23	084	311
001	67.0	XZ	044	25	085	315
002	69.3	WZ	045	26	086	331
003	71.9	XA	046	31	087	343
004	74.4	WA	047	32	088	346
005	77.0	XB	048	43	089	351
006	79.7	WB	049	47	090	364
007	82.5	YZ	050	51	091	365
008	85.4	YA	051	54	092	371
009	88.5	YB	052	65	093	411
010	91.5	ZZ	053	71	094	412
011	94.8	ZA	054	72	095	413
012	97.4	ZB	055	73	096	423
013	100.0	1Z	056	74	097	431
014	103.5	1A	057	114	098	432
015	107.2	1B	058	115	099	445
016	110.9	2Z	059	116	100	464
017	114.8	2A	060	125	101	465
018	118.8	2B	061	131	102	466
019	123.0	3Z	062	132	103	503
020	127.3	3A	063	134	104	506
021	131.8	3B	064	143	105	516
022	136.5	4Z	065	152	106	532
023	141.3	4A	066	155	107	546
024	146.2	4B	067	156	108	565
025	151.4	5Z	068	162	109	606
026	156.7	5A	069	165	110	612
027	162.2	5B	070	172	111	624
028	167.9	6Z	071	174	112	627
029	173.8	6A	072	205	113	631
030	179.9	6B	073	223	114	632
031	186.2	7Z	074	226	115	645
032	192.8	7A	075	243	116	654
033	203.5	M1	076	244	117	662
034	206.5	8Z	077	245	118	664
035	210.7	M2	078	251	119	703
036	218.1	M3	079	261	120	712
037	225.7	M4	080	263	121	723
038	229.1	9Z	081	265	122	731
039	233.6	M5	082	271	123	732
040	241.8	M6	083	306	124	743
041	250.3	M7			125	734
042	254.1	OZ			126	754

"Figure D" Motorola Tone Conversion Chart



The Special Programming mode (SPM) allows you to edit all user-modifiable parameters within your radio, such as the Channel Scan list, Phone Access/Deaccess codes, and Alert Tone Settings. Certain parameters (such as the Selective Call Tone Status) are only accessible with the installation of an option board. Upon entry to the Special Programming mode, the radio initiates the SPM Browse menu which provides you with a menu of available parameters and their current settings.

### To Enter the Special Programming Mode

1. Turn the radio on while holding down  (MEM) and keep  (MEM) holding until the radio sounds a ringing SPM start-up tone (takes about 3 seconds). At power-up, all display segments light for about 2 seconds.
2. If the battery voltage level is low, the display indicates and the 'BATT' Indicator flashes The radio also sounds a low battery alert tone. You must turn off the radio and replace, or recharge, the batteries.
3. If the batteries are above the threshold level, the radio enters the SPM Browse menu and the LCD displays the first menu item (i.e., the first parameter that can be modified). The first menu item is Edit Channel Scan List (ScnL .St ).
4. When In the SPM Browse menu, rotate the selector switch clockwise or counter clockwise to view the available parameters

### To Exit the Special Programming Mode

1. To exit the Special Programming mode, you must turn the radio off then on again.

### Restoring GP68 Factory Defaults

**WARNING** - this procedure will remove all custom programming from the radio's memory - it will reset the radio to unprogrammed state, as it came from the factory.

1. Turn the radio on while holding down  (MEM) and keep holding  (MEM) until the radio sounds a ringing SPM start-up tone (takes about 3 seconds). At power-up, all display segments light for about 2 seconds and the radio will now be in SPM mode.
2. Hold PTT and enter **13579** as the password.
3. Press ENTER (Yellow side button) to confirm after "**ErASE?**" comes up on the display.

Display will blank out, reset tone will be heard and "**-dONE-**" will appear on display.

4. Turn radio off. RESET to FACTORY DEFAULTS is complete.

### Edit the Channel Scan List

1. Rotate the selector switch to select the St menu item.

2. Use  (Left Arrow) or  (Right Arrow) to scroll through the channels (01 to 20).

A flashing channel number indicates that the channel is excluded from the scan list. A channel number that lights continuously indicates the channel is included in the scan list. For example, a display showing 18 with flashing digits indicates that channel 18 is excluded from the scan list.

3. Press the Toggle Light/Enter Button to toggle the state of a channel in the scan list from included to excluded, or from excluded to included.

4. To exit the scan list edit mode, select another menu item by turning the selector switch.

### Deleted a Programmed Channel

1. Rotate the selector switch to select the "ErAChn" menu item.



2. Use (Left Arrow) or (Right Arrow) to scroll through the channels (01 to 20).



3. Press the Toggle Light/Enter Button, the selected channel should flash.

### Edit Phone Access/Deaccess Codes

1. Rotate the selector switch to select the appropriate menu item.

2. Press any key (except the Toggle Light/Enter Button) to enter the edit mode. The LCD displays the currently programmed access/deaccess code. For a code, which exceeds the 6-digit display length, the rightmost digit flashes to indicate more digits exist on the right. You can now change or enter digits as required, up to a maximum of 8, using any of the numeric keys, as well as the \*, #, A, B, C, and D keys. The flashing cursor indicates the position of the next digit to be entered.

3. To change the access/deaccess code, Use  (Left Arrow) or  (Right Arrow) to scroll through the existing code's digits and  (X) to erase unwanted digits then enter the new digits. The display shows the new digits as they are being entered. When the flashing cursor is under a digit the maximum number has been entered.

4. One or more 'pause' digits can be entered between successive digits of phone access /deaccess codes by pressing  (Lock/\*) immediately followed by  (#). A pause digit is displayed as '-' (a dash). A pause digit causes the radio to wait in between transmission of the DTMF tones programmed before and after the pause.



5. Press the Toggle Light/Enter Button to store the new code and return to the SPM Browse menu

6. To abort the data entry, select another menu item by turning the selector switch or wait until the edit mode times-out (after 5 seconds of inactivity).

## **Edit Time Out Timer**

This menu item allows you to select the Time Out Timer length.



1. Rotate the selector switch to select the Edit Time Out Timer menu item. The menu will display the current setting: tot. xxx, where xxx represents one of OFF -01,-02,....,-10. The default display of tot. 01 shows the time out timer setting of one minute.

2. Use  (Left Arrow) or  (Right Arrow) to change the current status.

3. To exit this menu, select another menu item by turning the selector switch.

## **Set Selective Call Tone Status**



1. Rotate the selector switch to choose the 'Selective Call Tone Status' menu item. The LCD immediately indicates the current SelCall Tone status as either Sc-On (On) or Sc-OFF (Off).

2. Use  (Left Arrow) or  (Right Arrow) to toggle between 'On' end 'Off' - The new (displayed) status is saved immediately.

3. To exit this menu, select another menu item by turning the selector switch.

## **Set Sidetones Status**



1. Rotate the selector switch to select the 'Sidetone Status' menu item. The LCD immediately indicates the current Sidetone status as either St-On (on) St-OFF (Off)

2. Use  (Left Arrow) or  (Right Arrow) to toggle between 'On' and 'off' as required. The new (displayed) status is saved Immediately.

3. To exit this menu, select another menu item by turning the selector switch.

## **Set Alert Tone Volume**

1. Rotate the selector switch to select the 'Alert Tone' menu item. The LCD immediately indicates the current Alert Tones status as either Rt-OFF (Off) or Rt-On (On).

2. Use  (Left Arrow) or  (Right Arrow) to change the current status The new (displayed) status is saved immediately.

3. To exit menu, select another menu item by turning the selector switch.



**Placing a Telephone Call**

To place a call using manual access/ deaccess codes:

1. Press and hold PTT and then dial the access code using the DTMF keys.

2. Release PTT and wait for a dial tone.

3A. After dial tone is heard press and hold PTT and dial telephone number

OR

3B 3B. If your radio has preprogrammed telephone numbers,



press and hold PTT, press  (MEM) then press the number button that stores your preprogrammed telephone number.

4. Conduct conversation with other party. Press PTT to talk, release PTT to listen.

5. To hang up, press and hold PTT and then dial the deaccess code.



**To place a call using preprogrammed access/deaccess codes:**

1. Press and hold PTT, press  (MEM) and then press  (Lock/\*) to send the preprogrammed access code.

2. Release PTT and wait for a dial tone.

3A. After dial tone is heard, press and hold PTT and dial phone number

OR

3B. If your radio has preprogrammed telephone numbers

press and hold PTT, press  (MEM), then press the number button that stores your preprogrammed telephone number.

4. Conduct conversation with other party. Press PTT to talk, release PTT to listen.

5. To hang up, press and hold PTT, press  (MEM)

and then press  (#) to send the preprogrammed deaccess code.





## To Store a Phone Number



1. Press and hold  (MEM) until the radio sounds a second valid keypress tone (takes about 2 seconds).

The LCD display indicates that the radio is ready to accept a one-digit, entry.





2. To store a phone number, enter a phone number location in the range 1 to 9, using the numeric keypad. To store the access code press  (Lock/\*) to store the deaccess code, press  (#).

3. Enter the phone number (up to 12 digits long), or access/deaccess code (up to 6 digits long), using the numeric keypad. Valid digits are DTMF digits 0 to 9, the characters A, B, C, D, \* and #, and 'pause' digits (see next step). Any undefined digits are represented by underscores on the LCD. A flashing cursor (underscore) indicates the position for the next number entry if you reach the maximum number of entries, the cursor position is under the last digit

4. One or more pause digits can be entered between successive digits of the phone number (or access /deaccess code) by pressing  (Lock/\*) immediately followed by  (#). A pause digit is displayed as '-' (a dash), and causes the radio to wait in between transmission of the digits programmed before and after the pause.

5. If you make a mistake, use  (X) to scroll the cursor to the left and erase the incorrect entry.

6. To view a numeric sequence more than 6 digits use  (Left Arrow) or  (Right Arrow) to scroll the cursor to the left or right.

7. Press the Toggle Light/Enter Button to store the phone number (or access/deaccess code) into the designated location and return to normal operation.



## Last Number Redial

Manually dialed phone numbers (up to 16 digits long) are stored in numeric location for quick redial capabilities.

They are sent exactly as preprogrammed telephone numbers are. After you receive a dial tone, press and hold PTT, press  (MEM) then press the number button '0' (zero).



## To Display a Stored Phone Number

1. Press  (MEM) momentarily in the receive mode.
2. Enter a one-digit phone number location, in the range 0 to 9, using the numeric keypad. To view the access code press  (Lock/\*) to view the deaccess code, press  (#).

If the keypad entry is valid, the LCD displays the first 6 digits of the stored phone number or code. For number sequences greater than 6 digits, after 2 seconds the number begins autoscrolling to the left in 1 second Increments until the last digit is displayed.



## Optional DTMF Decoder Card

### Option Board Enable Procedure

The programming options are Selcal, Decode and Serial. To enable one of these options, turn the radio off, press and hold the '\*' key (bottom left of keypad, also the lock key), and turn on the radio.

The DTMF and SmarTrunk II options screen will appear on the display. The default is 'Opt.OFF'. Press the '>' (arrow down, sorry can't suplicate on my keyboard, it is the middle button on upper left keys) key and 'MEM <' (arrow up, bottom button on upper left keys) to show the options, SEL.CAL, dECODE, and SEriAL. Select 'dECODE' option for the DTMF option board.

If you are installing the SmarTrunk II option board, select 'SEriAL'. When the correct option is selected, turn the radio off to save it to memory.



If your radio is equipped with the Voice Selective Call option, your radio can be called individually by another user, or as part of a small group.

### Receiving a Voice Selective Call

1. When the radio decodes a Voice Selective Call, the LCD indicates the type of SelCall message being received as follows:



In the case of an Individual Call, you hear two short ringing tones. For other calls, you hear two medium pitched 'beeps'.

**NOTE:** Alert tones are not heard if either SelCall Tone Status or Alert Tone Volume is set to 'Off'.

2. For an Individual Call, the radio automatically transmits an Acknowledgement message back to the calling radio, If an Acknowledgement ID has been preprogrammed by the dealer. When the radio decodes a Voice Selective Call, it enters the carrier squelch mode for a period of time. If there is no receive activity the radio resumes the selected squelch mode and the LCD reverts to the appropriate receive mode display.

**IMPORTANT:** If you change the selector switch or press any buttons while the Selective Call signal is in progress, the SelCall message disappears and the Selective Call is lost.

### Sending a Voice Selective Call

1. Press and hold PTT, then dial the required Selective Call ID.

2. Release PTT and await a response.

**NOTE:** For an Individual Call, the radio indicates that the call was received with two short ringing tone.



Cloning duplicates the contents of Radio 1 (master radio) into Radio 2 (slave radio). Only current radio configuration, channels and phone numbers are copied from one radio to another. Tuning and alignment information are not affected by cloning. You need a cloning cable in order to perform this operation.

**SCI**

SCI stands for Serial Communications Interface; it is used to configure the GP68 radio and for radio to radio cloning. The SCI port is located at the side of the GP68 radio below the accessory connector.

**To Clone a Radio**



1. Lift the flap covering the SCI port of the master radio.
2. Insert the cloning cable jack into the SCI port.
3. Repeat steps one and two with the other end of the cloning cable and the slave radio. This connects both the master and slave radios.

4. Turn on the slave radio.

5. Turn on the master radio while pressing the **SIG/A** key.

6. The master radio will display the following message ("CLONE") if cloning can proceed, otherwise an error message will be shown (refer to 'Error Conditions' on page 40)



7. The slave radio displays the following message ("ProG") while it is being programmed.



If battery level is low, the slave radio will display "rPL.bAt" and you will need to replace or recharge the battery before repeating the procedure.

8. When cloning is completed, both radios will reset automatically.

9. Disconnect radios from the cloning cable and they are ready for operation.

**Possible Cloning Error Messages**

Err.01	Incompatible software.	Can't clone these two.
Err.02	Timeout error.	Check cable connection. Verify slave is on.
Err.03	Master checksum error.	Master needs to be serviced by dealer to enable cloning.
Err.04	No Programmed Channels.	If the slave, try again. If master - or slave still won't work - see dealer.

NOTE: The "master" radio must be "dealer programmable," i.e., it must have jumper R417 removed. The "slave" radio does not need to have R417 removed for successful cloning.

## Cloning Cable Pinout

### PMLN 4068 - GP-68 Cloning Cable

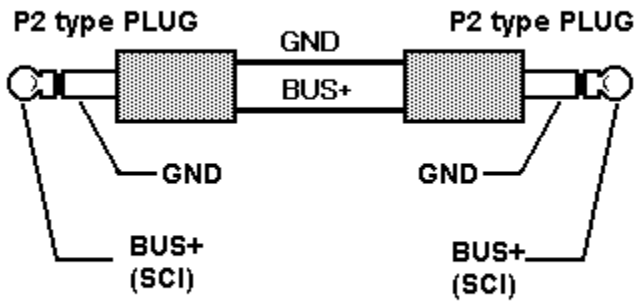

## Programming Cable Pinout

### PMLN 4074 RIB TO GP-68

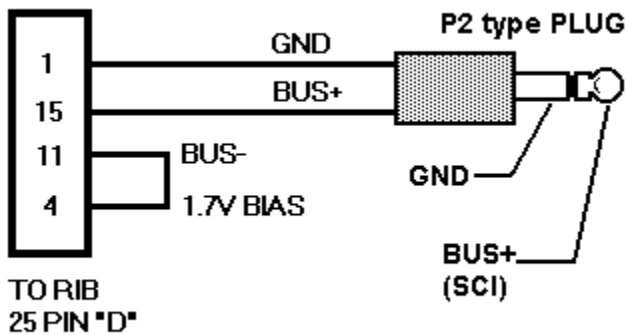

The programming cable is used for aligning the radio with the Motorola Radio Service Software (RSS). The RSS has NO other function than to service the radio, it is not for programming modes, editing repeater offsets, changing the scan list, changing frequencies, etc.

When you read the radio you only see some very basic information (bandsplit and model number).



# **MOTOROLA**