

 **MOTOROLA Radius™ m100/m200**  
Mobile Radios

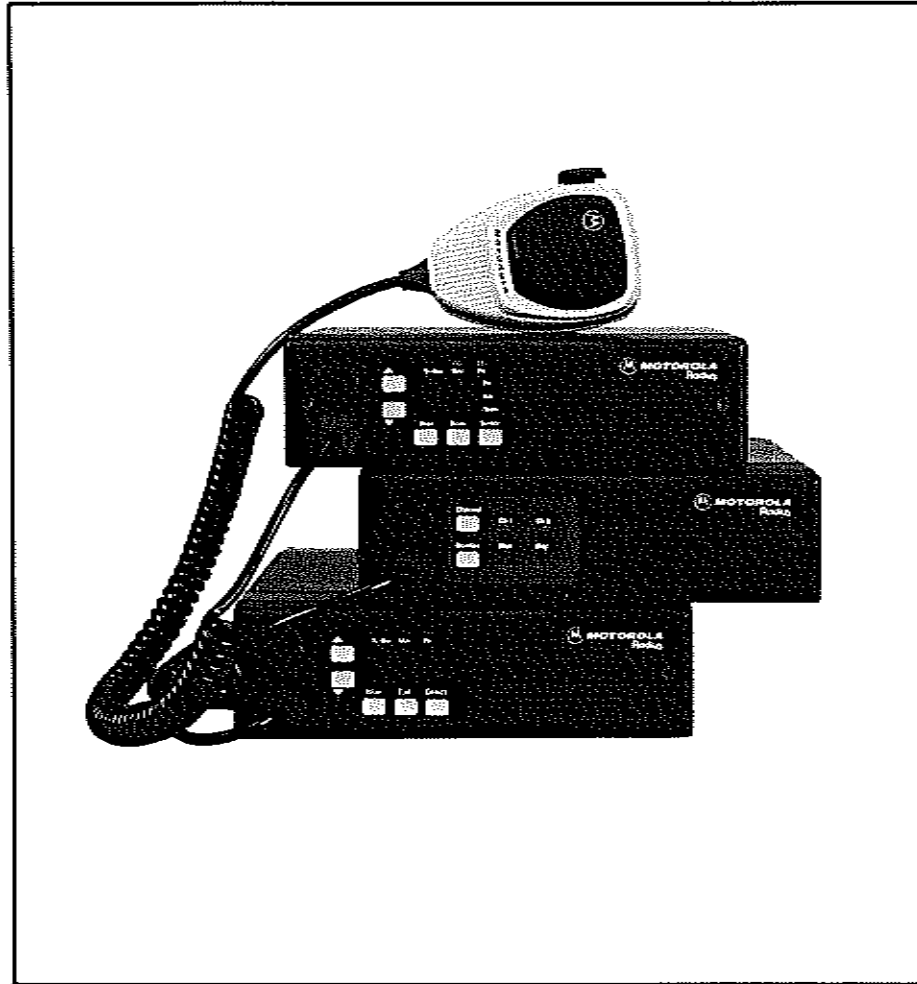

**Owner's  
Manual**

## CONTENTS

INTRODUCTION .....	1
Features List .....	1
Time-out Timer Feature .....	1
Radio Self-Check .....	1
Lowband Extender .....	1
OPERATING INSTRUCTIONS .....	2
M100 Operating Instructions .....	2
M208 Operating Instructions .....	3
M216 Operating Instructions .....	4
M216 CHANNEL SCAN .....	5
Channel Scan Description .....	5
Channel Scan Operation .....	5
Pre-programmed Scan .....	6
User Programmable Scan .....	6
Nuisance Delete Feature .....	7
Scan Feature Choices .....	7
ACCESSORIES AND ADVANCED FEATURES .....	8
Available Accessories .....	8
RapidCall Description .....	8
RADIUS RAPIDCALL OPERATING INSTRUCTIONS .....	9
Field Unit Operating Instructions .....	9
Control Unit Operating Instructions .....	11
ANI Operating Instructions .....	13
FIELD PROGRAMMING CAPABILITIES .....	14
FCC LICENSING AND SAFETY INFORMATION .....	14
FCC Licensing Requirements .....	14
FCC Safety Standards .....	16
Safety Guidelines .....	17
INSTALLATION PLANNING AND PROCEDURES .....	19
Equipment Testing and Maintenance .....	19
Description of Power Protection Circuitry .....	19
Location Planning .....	19
Recommended Tools .....	20
Antenna Mounting .....	20
Radio Mounting .....	20
Floor Mount .....	21
Extra Stability Mounting Tray .....	21
Locking Trunnion .....	21
BEGIN INSTALLATION .....	22
DC Power Cable Installation .....	22
Non-Locking Trunnion Installation .....	24
Sleeve Mounting Bracket Installation .....	26
COMPUTER SOFTWARE COPYRIGHTS .....	28

## INTRODUCTION

Welcome to the Radius mobile family! Your choice of a Radius mobile means you have selected the highest of standards in design, quality, and performance. This manual is designed to acquaint you with all the features, care, and installation of the Radius mobile to better serve all your communication needs.

### RADIUS MOBILE FEATURES

The following features are standard in all models:

- Synthesized, Wide-Band Operation
- Multiple Coded Squelch (Private Line and Digital Private Line) Capability
- Field Programming Capability
- Mil Spec 810 C and D Performance for Shock and Vibration
- Radius High Performance Compact Microphone with Hardware
- Non-Locking Trunnion with Hardware
- 10 Ft. Power Cable
- 12 V DC Negative Ground
- 3 Watt Internal Speaker
- Rotary Volume Control
- Time-Out-Timer
- On-Hook Monitor Capability
- Mini-UHF Antenna Connector
- Operator's Card and Owner's Manual

### TIME-OUT TIMER

All models have a Time-out Timer (TOT) that will terminate your transmission if you hold the PTT button down for 30 seconds. To warn the user, an alert tone will sound from the speaker about 4 seconds before the transmission is cut. The Time-out Timer can be disabled or changed in duration. See section on Field Programming for details.

### RADIO SELF-CHECK

Every time the radio is turned on, it performs a functional self-check and, if necessary, will sound a 5 second warning tone instead of the chirp tone normally heard at power-up. This is an indication that the radio is no longer operating at the exact parameters set in the factory or field and should be serviced immediately.

### LOWBAND EXTENDER

Lowband radios include an Extender circuit whose function is to blank out interfering noise pulses commonly found in the Lowband frequency range. This is also known as a Noise Blanker. The Extender is always enabled when the radio is turned on. It can be disabled with an extended hold (4 seconds, 3 chirps) of the Monitor button. The channel display will indicate the Extender is disabled with a dash (-). To enable the Extender function again, press the Monitor button as before (4 seconds, 3 chirps).

## Operating Instructions Radius M100

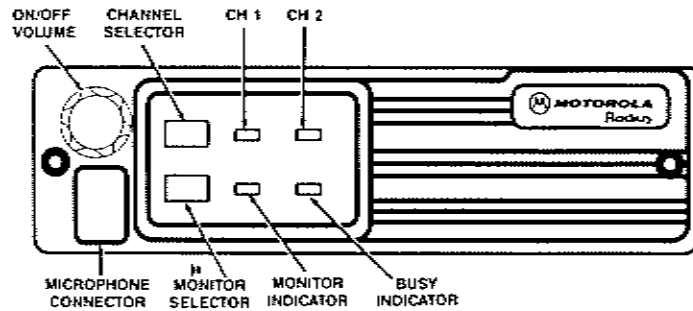

### To turn the radio on

Turn the ON/OFF VOLUME knob to the right until it clicks. A tone will be heard. Only those LEDs indicating the last status of the radio will light.

### To receive

Set the volume by turning the ON/OFF VOLUME knob clockwise. One half turn equals about 50% audio output.

Select the channel by pressing the CHANNEL button. Each press of the button will allow you to jump between channels. Release the key when you reach the desired channel. When in the receive mode, the CHANNEL INDICATOR LED will be green.

If you wish to monitor a channel, press the MONITOR button. You may also enter the monitor mode by taking the microphone off the hook. When in the monitor mode, the amber MONITOR INDICATOR LED will light steadily.

To unscquelch the radio, press the MONITOR button for 2 seconds. This unmutes the speaker. Adjust the volume by using the ON/OFF VOLUME knob.

To leave the unscquelched mode, press the MONITOR button. This will return the radio to the coded squelch (PL/DPL) mode. To return to the monitor mode, press the MONITOR button again.

When you press a button to change modes or channels, you will hear a short beep tone.

### To transmit

The amber BUSY INDICATOR will flash if there is another carrier on the channel. Do not transmit if anyone else is using the channel. If the channel is clear, press the PTT (push to talk) button on the side of the microphone. The CHANNEL INDICATOR LED will turn red to indicate that you are "on the air". It will remain red until the PTT button is released.

Hold the microphone about two inches from your mouth and speak at a normal voice level. DO NOT SHOUT. It will not make your transmission clearer.

## Operating Instructions Radius M208

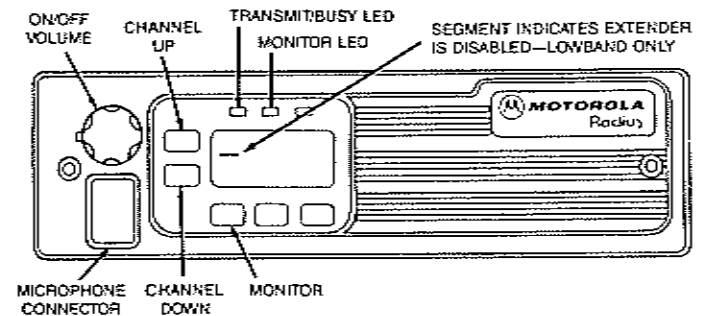

### To turn the radio on

Turn the ON/OFF VOLUME knob to the right until it clicks. A tone will be heard. Only those LEDs indicating the last status of the radio will light.

### To receive

Set the volume by turning the ON/OFF VOLUME knob clockwise. One half turn equals about 50% output.

Select the channel by pressing either the CHANNEL UP or CHANNEL DOWN button. The channel number will be displayed. An extended hold of either button will allow you to scroll through all active channels in ascending and descending order.

If you wish to monitor a channel, press the MONITOR button to disable coded squelch. You may also enable the monitor function by taking the microphone off the hook. When in the monitor mode, the amber MONITOR INDICATOR LED will light steadily.

To unscquelch the radio, press the MONITOR button for 2 seconds. This unmutes the speaker. Adjust the volume by using the ON/OFF VOLUME knob.

To leave the unscquelched mode, press the MONITOR button. This will return the radio to coded squelch operation. To return to the monitor mode, press the MONITOR button again.

When you press a button to change status, you will hear a short chirp tone.

**NOTE:** Lowband Radios include an EXTENDER circuit whose function is to blank out interfering noise pulses commonly found in Lowband. The EXTENDER is always enabled when the radio is turned on. It can be disabled (or enabled again) with an extended hold (4 seconds, 3 chirps) of the MONITOR button.

### To transmit

The red TRANSMIT/BUSY INDICATOR will flash if there is another carrier on the channel. Do not transmit if anyone else is using the channel. If the channel is clear, press the PTT (push to talk) button on the side of the microphone. The TRANSMIT/BUSY INDICATOR will light steadily to indicate that you are "on the air". It will remain lit until the PTT button is released.

# Operating Instructions

## Radius M216

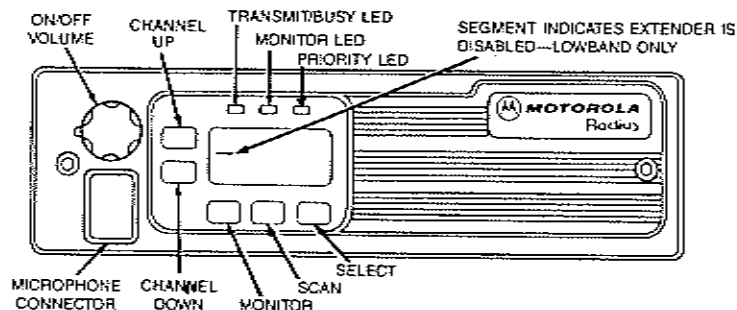

### To turn the radio on

Turn the ON/OFF VOLUME knob to the right until it clicks. A tone will be heard. Only those LEDs indicating the last status of the radio will light.

### To receive

Set the volume by turning the ON/OFF VOLUME knob clockwise. One half turn equals about 50% output.

Select the channel by pressing either the CHANNEL UP or CHANNEL DOWN button. The channel number will be displayed. An extended hold of either button will allow you to scroll through all active channels in ascending and descending order.

If you wish to monitor a channel, press the MONITOR button to disable coded squelch. You may also enable the monitor function by taking the microphone off the hook. When in the monitor mode, the amber MONITOR INDICATOR LED will light steadily.

To un-squelch the radio, press the MONITOR button for 2 seconds. This unmutes the speaker. Adjust the volume by using the ON/OFF VOLUME knob.

To leave the un-squelched mode, press the MONITOR button. This will return the radio to coded squelch operation. To return to the monitor mode, press the MONITOR button again.

When you press a button to change status, you will hear a short chirp tone.

**NOTE:** Lowband Radios include an EXTENDER circuit whose function is to blank out interfering noise pulses commonly found in Lowband. The EXTENDER is always enabled when the radio is turned on. It can be disabled (or enabled again) with an extended hold (4 seconds, 3 chirps) of the MONITOR button.

### To transmit

The red TRANSMIT/BUSY INDICATOR will flash if there is another carrier on the channel. Do not transmit if anyone else is using the channel. If the channel is clear, press the PTT (push to talk) button on the side of the microphone. The TRANSMIT/BUSY INDICATOR will light steadily to indicate that you are "on the air". It will remain lit until the PTT button is released.

## M216 CHANNEL SCAN

If your Radius mobile is the M216 model, the radio includes Channel Scan monitoring. The radio may come with **pre-programmed scan** lists dedicated to every active channel (channel-slaved). The user selects a particular channel and turns on scan, choosing either "scan" or "priority scan".

The radio user can also program one unique **user programmable scan** list from the front panel of the radio which is retained in memory until changed or deleted by the user. To access this list, choose either "user scan" or "priority user scan".

Both types of scan operate in either non-priority or priority modes. Non-priority scan means that every channel on the scan list is monitored equally. However, with priority scan, certain channels have "priority" over others and are checked more frequently. If you are scanning with priority, the radio will continually check for activity on your priority channels even when you are listening to a message on another channel and there may be short gaps in the audio. The radio will continue to check Priority One even while receiving a call on Priority Two.

With pre-programmed scan the channel you have selected is always the Priority One channel. The Priority Two channel is pre-programmed and is the same for every scan list. With user programmable scan, the priority channels are designated by the operator.

### CHANNEL SCAN OPERATION

To turn scan on or off, press the SCAN button. However, the radio will only scan when on-hook. The channel display will blank and a green horizontal segment(s) will light to indicate which type of scan is functional. For your convenience, the display will indicate the most recently selected scan status.

Use the SELECT button to advance through the scan types:

scan	user scan	priority user scan	priority scan
Pri	Pri	— Pri	— Pri
Usr	— Usr	— Usr	— Usr
— Scan	— Scan	— Scan	— Scan

**NOTE:** The first and last displays apply to the pre-programmed (channel-slaved) scan lists and will be the only ones operational until the operator programs a user scan list into the radio.

When an active channel with the correct signalling code is detected, the channel number will be displayed and you will hear the call. If you have pressed the MONITOR button, the scan will disregard squelch codes and scan for all activity on each channel in the scan list.

If you are in the scan mode when the power is turned off, the radio will return to the scan mode when powered up again. To leave scan, press the SCAN button.

To respond to scanned channel activity, lift the microphone off-hook. The radio will suspend scanning and return to the channel displayed before entering scan. If you wish to respond to a transmission on another channel, you must use the UP/DOWN buttons to reach that channel. To resume scanning replace the microphone on-hook.

In priority scan, the green priority LED will flash to indicate activity on Priority One and light steady for Priority Two.

#### PRE-PROGRAMMED SCAN

Each active channel in the radio can have a pre-programmed scan list dedicated to it. Through the use of Radius Service Software and a computer at a service location, any combination of sequential frequencies may be programmed into each active list.

Priority One is always assigned to the selected channel. Priority Two can be designated by the servicer or deleted altogether. However, the radio can only have one designated Priority Two channel. Therefore, Priority Two must be the same channel in each scan list. For example, if channel 3 has been programmed as the second priority in a scan list, channel 3 will be the second priority channel in the remaining active scan lists.

The Radius M216 mobile scans at a rate of approximately 250 milliseconds per channel. Therefore, scanning more than eight frequencies is not recommended.

#### USER PROGRAMMABLE SCAN

A single user scan list (one per radio) can be programmed from the front panel by the operator and will be retained in memory until changed or deleted. This is separate from the scan lists pre-programmed to each active channel.

To create or modify the User Scan List, hold the SCAN button down for 2 seconds until you hear a second chirp tone. The channel number will flash. Add or delete this channel from the list by pressing the SELECT button.

A vertical segment in the upper left corner of the display will light to indicate that the flashing channel has been added to the user scan list. It will disappear when the channel is deleted.

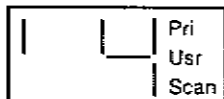

To complete the user list, push the UP/DOWN buttons until you reach the desired channel. Use the SELECT button to add or delete.

To select priorities for the user list, go to the desired channel and hold the SELECT button down for two seconds. The priority LED will flash to indicate that the displayed channel is designated as the Priority One channel. Repeat the process to select a Priority Two channel, if desired, which will be indicated by a steady light on the PRIORITY LED.

It's important to note that the Priority One channel is programmed first followed by the Priority Two Channel. To set different priorities, deleting either one will delete both priority channels at the same time. Then reset either or both priority channels as described above.

#### NUISANCE CHANNEL DELETE

Each of the Radius M216 mobile's scan types feature Nuisance Channel Delete. If a channel in a scan sequence is at times in heavy use by another operator causing the radio to be continually monitoring that channel, you may wish to temporarily eliminate that channel from the scan list without reprogramming the radio. When receiving a transmission on that channel, simply hold down the SELECT button for two seconds and the nuisance channel will be temporarily deleted until that scan mode is changed or exited. Priority channels and the home channel cannot be deleted.

#### SCAN FEATURE CHOICES

In addition to changing pre-programmed (channel slaved) scan lists and the second priority channel, the Radius Radio Service Software also provides the capability for "talk-back" scan. If this feature is enabled, the radio will remain on the active channel when the mic is taken off-hook instead of returning to the selected (home) channel. This allows the user to respond or "talk-back" to a transmission received on a scanned channel.

The Radius programming software also provides the ability to change the frequency with which a priority channel is checked. When the channel scan is stopped on a non-priority channel, it periodically "checks" the priority channel for activity. The rate at which this occurs is the priority sample rate. There are two rates available: fast is 0.5 seconds and slow is 1.5 seconds. Although the fast rate provides more assurance that a message won't be missed, it is, in effect, interrupting the current reception more often. Therefore, the radio is normally programmed for slow.

## ACCESSORIES AND ADVANCED FEATURES

### AVAILABLE ACCESSORIES:

External Speaker—5 watt for high noise environments  
Non-Locking Mounting Trunnion  
Extra Stability Mount—used with non-locking trunnion for high vibration environments  
Key Lock Mount  
45°–60° Floor Mount Wedge  
Sleeve Mounting Bracket  
Ignition Switch Cable—to turn on/off with the ignition  
Compact Palm Microphone  
Heavy Duty Microphone  
DTMF Microphone  
Control Station Accessories include:  
Desk Microphone  
Mounting Tray  
Power Cable  
Power Supply (Low Current)  
Power Supply (High Current)

### RAPIDCALL SIGNALLING

Radius mobiles are available with RapidCall, a selective signalling package. Radios can be programmed with an impressive variety of features to improve your efficiency as radio users. These features include: Push-to-Talk Identification (PTT-ID), Emergency, Call Alert, Horn/Lights, Voice Selective Call, and Radio Check.

M200 mobiles can be made capable of **sending** a unit ID or Emergency Alert to a control unit or **receiving** a Call Alert, Horn/Lights, Voice Selective Call or Radio Check from a control unit.

Mobile radios can also be made capable of the control unit functions: **receiving and displaying** the incoming ID or Emergency and **sending** a Call Alert, Horn/Lights, Voice Selective Call or Radio Check.

In addition, RapidCall mobiles have an expanded accessory connector, providing greater flexibility in adding external hardware such as Public Address. Ask your Radius Representative for more information.

## Operating Instructions for Motorola Radius RapidCall Mobile Radios Mobile (Field Unit) Selective Signalling

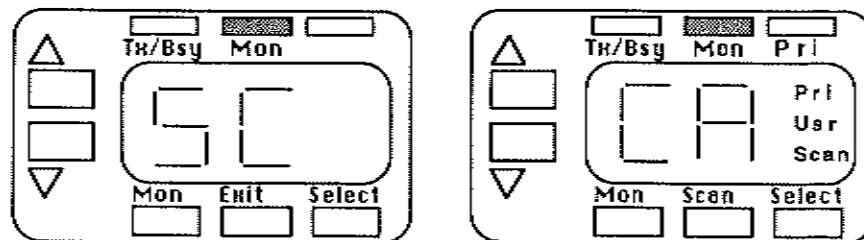

The Monitor LED lights steady in normal operation to indicate monitor mode. To indicate an incoming selective call, the Monitor LED will flash and the display will show the appropriate letter abbreviations.

### Receiving a Voice Selective Call

When a Voice Selective Call is received a one-time 2 beep alert tone will sound, the amber Monitor LED will flash and the display will show "SC".

The radio will unmute and a voice message will follow. After the transmission is completed, the radio returns to normal operation.

### Receiving a Call Alert

When a Call Alert is received the amber Monitor LED will flash and a series of 4 alert tones will sound. The display will show "CA". Depending on the signalling format used, a voice message may follow.

A Call Alert "leaves a message" for the mobile operator. The Monitor LED will continue to flash, the "CA" will remain on the display and the alert tones will repeat every 10 seconds until the PTT or any other button is pressed. The radio will then return to normal operation.

### Receiving an External Alarm (Horn/Lights)

The External Alarm or Horn/Lights function requires an alarm relay cable. To enable an incoming Call Alert to turn on the horn and/or lights, press the SELECT button and the display will show "HL". The duration of the external alarm is 6 seconds.

There will be a slight delay before the horn/lights relay is closed. An operator in or near the vehicle who sees or hears the Call Alert indication will have the opportunity to turn off the External Alarm before it sounds. This is done by pressing any button or taking the microphone off-hook.

## Mobile Selective Signalling

### Sending an Identification Number

Every time the Push-to-Talk key is pressed, the radio automatically transmits a unit identification (ID) number. While holding the PTT key, a tone may be heard while the unit ID number is being sent out. Do not begin talking until the tone is over.

### Sending an Emergency Alarm

Emergency alarm requires the press of an external footswitch or pushbutton to send the emergency call.

If programmed for STANDARD EMERGENCY, the following will occur:

- The operator will hear a single alert tone when the Emergency is sent by the radio and the transmit LED will light.
- The letters "EE" will appear on the display.
- Five alert tones will sound to indicate the Control unit has received and acknowledged the Emergency. The "EE" will then disappear from the display.
- Messages will be heard over the radio's speaker during the Emergency.
- Monitor and Busy LED's will function normally during the Emergency.
- The only way to cancel the emergency is by pressing Push-to-Talk. No other button will function normally except Monitor.

If programmed for EMERGENCY REVERT, the radio will automatically change (revert) to an emergency channel to send the call. The channel display will show the emergency channel after the "EE" clears.

If programmed for SILENT EMERGENCY, there will be no audio or visual indication that the emergency call was sent and the radio will remain muted. The operator must press Push-to-Talk to initiate a voice message.

### Signalling and Channel Scan

Signalling and scan are compatible. However, during scan operation, a selective call on a particular channel could be missed since the radio may not be checking that channel when the selective call is sent.

It is recommended that priority scan is selected and the signalling channel be designated a priority channel to improve the likelihood that the selective call will be received.

## Control Unit Selective Signalling

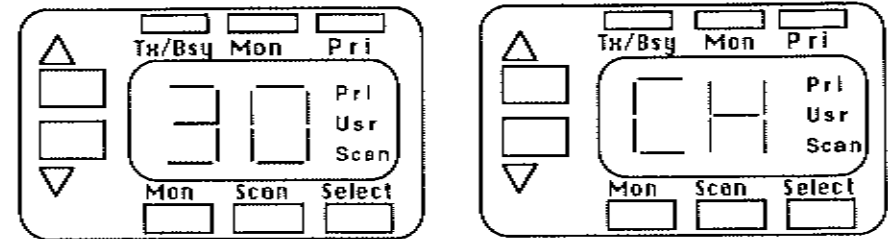

### Display of Incoming Identification Numbers

Whenever an operator in the system presses the Push-to-Talk (PTT) key, the unit identification number (ID) will be shown on the display for 10 seconds or less if another incoming ID is received.

### Activating the Call List for Sending Selective Messages

Pressing the Select button will activate the Call List. The most recently used ID number and the call letters will alternately be displayed. The following call letters may be displayed when using a call list.

- SC**—Voice Selective Call: Call a particular unit or group with a voice message.
- CA**—Call Alert: Select a unit or group and leave a "call-back" indicator.
- CH**—Radio Check: Check to see if a unit is turned on and within range.

These letters will alternate on the display with the unit or group ID number.

### Changing Call List Letters and ID Numbers.

Each press of the Select button causes the display to move down the list of call letters which have been programmed in the unit.

Pressing the Up/Down buttons will change the ID numbers. All Call List ID numbers will be displayed with each set of call letters. However, some ID's may not be compatible with certain call types. For example, a group ID cannot be Radio Checked. In such cases, pressing PTT will result in a low pitched tone to indicate that the function is not available.

### Sending a Signalling Message

Once the desired call letters and ID numbers have been selected, pressing PTT will send the message. The display will revert to the preprogrammed transmit channel to send the signalling message and the channel will be briefly displayed while the message is being transmitted.



## Control Unit Selective Signalling

### Receiving an Acknowledgement

Depending on the signalling format used, the sending radio may look for an acknowledgement from the receiving unit on Call Alert and Radio Check calls.

The sending radio will show an "A" and 4 alert tones will sound if the target unit received and acknowledged the call. If no acknowledge is received, the sending unit will make another 4 tries. If unsuccessful, a "-A" will be displayed and a low pitched tone will sound to indicate no acknowledge.

### Exiting the Call List

The Select button can be used to exit the signalling call list. Repeated pressing of the Select button takes one through the sequence of call letters to the channel display for normal operations.

M208 radios also have an EXIT button. A single press of the Exit button will take the radio out of signalling and return to the channel display at any time.

### Receiving an Emergency Alarm

When an emergency alarm is received by the control unit, an alert tone will sound. The display will alternate "EE" and the ID number of the radio sending the emergency.

Five different emergency ID's can be queued. However, the first ID to be received will be displayed until it is cleared. Then the next ID in the queue will be displayed until each has been displayed and cleared.

### Clearing an Emergency Alarm

To prevent accidentally losing an incoming emergency, the clearing of an emergency alarm has been designed as a two step process. First the alert tone must be cleared by any button press on the radio.

The second step requires the use of an external pushbutton or footswitch. Only a press of the external switch will clear the Emergency display.

## DTMF ANI PHONE ACCESS OPERATING INSTRUCTIONS

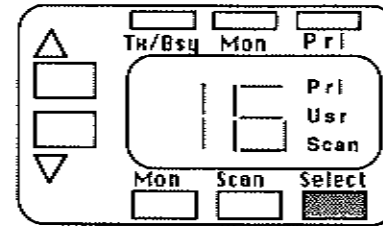

Radio is in normal operating mode.

Check the Busy LED to be sure the channel is free before pressing the Select button. See Note 1.

Press the Select button. The DTMF access code will automatically be transmitted and "PH" will appear on the display. See Note 2.

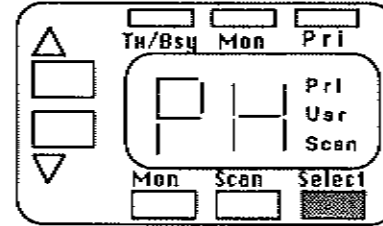

A call can be manually dialed using the standard Touch Code microphone. The radio will be in carrier squelch mode.

Press Select after the call is completed to send the deaccess code. The radio returns to normal operating mode and its prior monitor or coded squelch state. See Note 3.

**Note 1.** If you press the Select button when the channel is busy you will hear a low pitched tone. The radio will revert to monitor mode so you can listen for a free channel. Press the Select button again to send the Access code.

**Note 2.** If the patch missed the Access code when it was sent, the user would have to press Select twice to reaccess the patch: once to deaccess and again to access. The same case is true for Deaccess.

**Note 3.** If the radio reverted to monitor mode because of a busy channel before Access, it will return to monitor after Deaccess. Otherwise the radio will return to coded squelch.

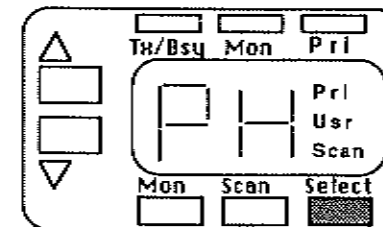

## PHONE MEMORY LIST

Up to 14 telephone numbers can be programmed by the dealer. One or two digit identifiers will then be used to represent these phone numbers.

Press the Select button to enter Phone mode. Select the Phone Memory List by using the Up/Down arrow keys. The first press of the Up/Down button will recall the last phone number dialed. (This is not saved if the radio has been turned off.)

Subsequent or extended presses of the Up/Down buttons will step through the list.

Press PTT to send a call to the selected number from the list. Radio reverts back to Phone mode after memory dialing is complete.

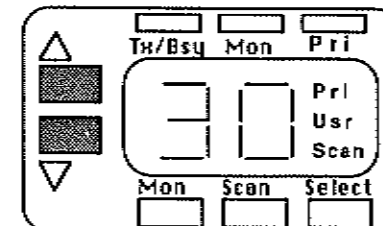

## FIELD PROGRAMMING CAPABILITIES

The Radius mobile uses non-volatile memory to store customer unique information. If a frequency, squelch code or channel-slaved scan list needs to be changed, it can be done at a service location with Radius Service Software. The time-out timer can be disabled or changed to any duration from 1 to 255 seconds. The default setting is 30 seconds. It is not necessary to open the radio for reprogramming.

Scanning radios can also be programmed to enable Talk-back Scan or the Priority Sample Rate can be changed. See page 7 for details. Finally, radios ordered with RapidCall Signalling and Expanded Accessory Connector can be programmed to include a wide variety of features and accessories.

## FCC LICENSING AND SAFETY INFORMATION

### FCC LICENSING INFORMATION

Your Radius radio operates on FM radio communication frequencies and is subject to the Rules and Regulations of the Federal Communications Commission (FCC). The FCC requires that all operators using Private Land Mobile or General Mobile Radio frequencies obtain a radio license before operating their equipment. Application for your FCC license is made on FCC Form 574 for low band, high band, and UHF frequencies. For a license in the 800 MHz band, you must complete the Form 574 and 574-A Supplemental form. These forms as well as a booklet entitled "Form 574 Instructions" can be obtained from the FCC Supply Section, Administrative Services Division, 1919 M St., NW, RM B-10, Washington DC 20554; telephone 202-632-7272.

The operator receives a license for use of the radio equipment under a specific eligibility and on a particular frequency or set of frequencies. To determine eligibility for use of Private Land Mobile Service frequencies, see FCC Rules and Regulations, Part 90. These may be found in the Code of Federal Regulations (CFR) at 47 C.F.R. Part 90. The following subparts describe general eligibility requirements:

- Subpart B: Public Safety Radio Services
- Subpart C: Special Emergency Radio Services
- Subpart D: Industrial Radio Services, which include, among others, Business, Manufacturers and Special Industrial Services
- Subpart E: Land Transportation Radio Service

Eligibility for use of the General Mobile Radio Service frequencies is found under Part 95 of the Rules and Regulations, 47 C.F.R. 95, subpart A.

Frequency coordination is now required for operation on most frequencies in the Private Land Mobile Radio Services. Once the license application form is completed it must be forwarded to the appropriate frequency coordination agency which is determined by the operator's eligibility classification. The coordination agency assigns a frequency or frequency pair to the application and forwards it on to the FCC for final processing. There is a frequency coordination fee which must be included with the license application. Current fee charges can be obtained by calling your appropriate frequency coordination agency. See listing on the reverse side of this sheet.

An exception to the requirement for frequency coordination in the Private Land Mobile Radio Services is licensing for use of itinerant frequencies. Itinerant operation is defined by the FCC as operation of a radio station at unspecified locations for varying periods of time. Those applications do not need frequency coordination and may be sent directly to FCC. Frequency coordination is also NOT required for licenses in the General Mobile Radio Service and these applications are also sent to the FCC. See the reverse side for these FCC addresses.

The FCC charges a processing fee for all new, modified or renewal license applications. This fee is payable by check or money order made out to the "Federal Communications Commission" and MUST be enclosed with the application. Any application without a check will be returned. (Exception: Applicants who are governmental entities and all applicants in any Public Safety or Special Emergency Radio Service are exempt from the FCC license fee.) Applications requiring coordination must have the FCC check, as well as the coordinator's check, attached when mailed to the coordinating agency. The coordinating agency will remove their check and will forward the coordinated application and FCC check on to the FCC Licensing Division. Upon grant, the FCC will mail your radio station license to the address shown on your application Form 574.

If your eligibility is within the Business Radio Service, contact the National Association of Business and Education Radio (NABER) for the NABER fee schedule and supplemental form to be completed and forwarded with Form 574 to:

NABER Frequency Coordination  
1501 Duke St., Suite 200  
Alexandria, VA 22314  
Tel 703-739-0300

The Business Radio Service itinerant frequencies are 27.49 MHz, 35.04 MHz, 151.625 MHz, 464.500, 469.500 MHz pair and 464.550, 469.550 MHz pair. Complete Form 574 and send to:

FCC-Business Radio Service  
PO Box 360291-M  
Pittsburgh, PA 15251-6291  
Tel 717-337-1212

If your eligibility is within the Special Industrial Radio Service, contact the Special Industrial Radio Service Association (SIRSA) for the SIRSA fee schedule. Complete Form 574 and send to:

SIRSA Frequency Coordination Dept.  
1700 N. Moore St. Suite 910  
Rosslyn, VA 22209  
Tel 703-528-5115

The Special Industrial Radio Service itinerant frequencies are 43.04 MHz, 151.505 MHz, 158.400 MHz, and 451.800, 456.800 MHz pair. Complete Form 574 and send to:

FCC-Other Industrial Services  
PO Box 360354-M  
Pittsburgh, PA 15251-6354  
Tel 717-337-1212

If your eligibility is within the Manufacturer Radio Service, contact Manufacturers Radio Frequency Advisory Committee (MRFAC) for the MRFAC fee schedule and supplemental form to be completed and forwarded with Form 574 to:

MRFAC, Inc.  
6269 Leesburg Pike, Suite 304  
Falls Church, VA 22044  
Tel 703 532-7459

If you want to operate on General Mobile Radio Service frequencies, complete Form 574 and send to:

FCC-General Mobile Radio Service  
PO Box 360373-M  
Pittsburgh, PA 15251-6373  
Tel 717-337-1212

For information on other frequency coordinating agencies or additional licensing information, contact the FCC, 2025 M St. NW, Washington, DC 20554; telephone 202-632-7272.

#### **SAFETY STANDARD**

The FCC, with its action in General Docket 79-144, March 13, 1986, has adopted a safety standard for human exposure to radio frequency electromagnetic energy emitted by FCC regulated equipment. Motorola subscribes to the same safety standard for the use of its products. Proper use of this radio will result in exposure below government limits.

The following precautions are recommended:

—DO NOT operate the transmitter of a mobile radio when someone outside the vehicle is within two feet (0.6 meter) of the antenna.

—DO NOT operate the transmitter of a fixed radio (base station, microwave, the rural telephone RF equipment) or marine radio when someone is within two feet (0.6 meter) of the antenna.

—DO NOT operate the transmitter of any radio unless all RF connectors are secure and any open connectors are properly terminated.

—DO NOT operate the equipment near electrical blasting caps or in an explosive atmosphere.

—All equipment must be properly grounded according to Motorola installation instructions for safe operation.

—All equipment should be serviced only by a qualified technician.

Refer to the appropriate section of the product service manual for additional pertinent safety information.

#### **SAFETY GUIDELINES:**

##### **INSTALLATION SAFETY WARNING**

Consider the occupants' safety when you choose a location for the radio. Do not mount the radio overhead or on a sidewall unless you take special precautions.

If someone were to remove the radio and fail to replace it properly, road shock could bump the radio loose, and the falling radio could, in some circumstances, cause serious injury to the driver or a passenger. In a crash, even when properly installed, the radio could break loose and become a dangerous projectile.

If you must mount the radio overhead or on a sidewall, give it the added protection of a retaining strap.

##### **OPERATIONAL SAFETY WARNINGS**

---

###### **WARNING**

For vehicles equipped with electronic anti-skid systems, see "ANTI-SKID BRAKING PRECAUTIONS" Publication, Motorola Number 68P81109E34.

---

---

###### **WARNING**

For vehicles equipped with electronic ignition systems, check the service manual for warnings about the use of two-way radio equipment in the vehicle.

---

---

###### **WARNING**

It is mandatory that radio installations in vehicles fueled by liquefied petroleum gas conform to the following standard:

---

National Fire Protection Association standard NFPA 58 applies to radio installations in vehicles fueled by liquefied petroleum (LP) gas with LP gas container in the trunk or other sealed-off space within the interior of the vehicles. This standard requires that:

1. Any space containing radio equipment shall be isolated by a seal from the space in which the LP-gas container and its fittings are located.
2. Remote (outside) fitting connections shall be used.
3. The container space shall be vented to the outside.

## CAUTION

### INSTALLATION OF ANTENNAS WITH MOBILE RADIO EQUIPMENT WITH TRANSMITTER POWER IN EXCESS OF 7 WATTS

**NOTE:** For low power mobile radios or Cellular radios (7 watts or less), there are no antenna type or installation restrictions.

**Non-Metallic Body Vehicles** - In non-metallic body vehicles with transmitters at any frequency having a power output in excess of 7 watts, do not install any type of antenna closer than 2 feet in distance from any occupant of the vehicle. Failure to follow this procedure may result in the exposure of the vehicle occupants to radio frequency energy levels higher than recommended by the American National Standards Institute (ANSI).

**Metal Body Vehicles** - In metal body vehicles with transmitters at any frequency having a power output in excess of 7 watts, it is mandatory that when using a glass mount antenna the installation instructions covering the location of the antenna at the top of the front or rear window and the cable routing be followed exactly as described. Failure to follow this procedure may result in the exposure of the vehicle occupants to radio frequency energy exposure levels higher than recommended by the American National Standards Institute (ANSI).

For other antenna types follow the existing installation instructions. The best location for the antenna is at the center of vehicle roof. A good alternate location is at the center of the trunk lid.

**IMPORTANT** - If installations different from these recommendations have already taken place, immediately notify your local Service Representative so that appropriate corrective action can be taken.

## CAUTION

### UNSAFE USE OF CONVERTED MOBILE EQUIPMENT FOR PORTABLE APPLICATIONS

Motorola two-way radio products which have been designed for mobile operation **should not** be used as battery operated portable units. In such use there is the danger that the user or other persons will be exposed to excessive radio frequency energy levels. This warning applies to all two-way radio equipment radiating in excess of seven (7) watts RF power. Motorola strongly recommends that any product which converts high power equipment for portable operation **not be used**.

## INSTALLATION PLANNING AND PROCEDURES

### Testing and Maintenance

Your radio is completely adjusted, tested, and inspected before shipment. However, FCC regulations state that a station license must be obtained for each radio installation (mobile or base) by the owner of the equipment. The station licensee is responsible for ensuring the transmitter power, frequency, and deviation are within the limits permitted under the station license.

No technician's license is required for installing and maintaining radio equipment. However, the frequency and deviation of the transmitter must be checked on installation and at least once yearly.

### Power Protection Circuitry

The Radius mobile you are installing has been tested for proper transmitter power output before leaving the factory. Each radio is set to the proper output power level while connected to an accurate 50 ohm load impedance. Once the power level has been set, the internal power control/protection circuitry will reduce the power output whenever it senses a load impedance significantly different from 50 ohms. This protection circuitry significantly enhances the radio's reliability with minimal performance degradation.

If you check transmitter output power levels during installation, be sure you are using a good 50 ohm load, with a minimum of adapters and using short test cables. Any load variation from 50 ohms may cause an apparent reduction in output power due to the normal operation of the control/protection circuitry. These variations in power with other than 50 ohms load impedance will be most pronounced in the 800 MHz band since cables, meters, connectors, etc. have larger effects in that band. However, the factors are still significant at UHF and VHF and considerable care should be exercised at these frequencies. If power seems to be unusually low (greater than can be explained by the normal calibration differences you experience), check your test set-up. If power output goes up as you improve the quality of the load impedance (be sure to de-key when making any changes in load), the control/protection circuitry is performing normally.

Typical mismatches in the load impedance (greater than 1.2:1 VSWR) may result in a 10-20% variation in the actual measured power output. Within these limits, the radio operates normally and you should not attempt to service it.

### INSTALLATION PLANNING—MOBILE RADIOS

Planning is the key to fast, easy radio installation. Before a hole is drilled or a wire is run, inspect the vehicle and determine how and where you intend to mount the antenna, radio, and accessories. Plan wire and cable runs to provide maximum protection from pinching, crushing, and overheating.

## INSTALLATION PLANNING—BASE/CONTROL STATIONS

The base/control station option provides the radio with a desk microphone and power supply for use at a fixed location. All operations are the same as the mobile, except for the desk microphone.

Choose a location for your base/control station as close as possible to where the antenna cable enters the building. Be sure 117V AC, 60 Hz power is available. Make sure sufficient air can flow around the radio to permit adequate cooling.

### RECOMMENDED TOOLS FOR INSTALLATION

The following tools are recommended for proper installation of your new radio.

- Portable Drill
- Hammer
- Center Punch
- 5/16" Hex Nut Driver
- 1/4" Hex Nut Driver
- Phillips #2 Screwdriver
- TORX Screwdriver, T25
- 3/8" Diameter Drill Bit
- 5/16" Diameter Drill Bit
- 5/32" Diameter Drill Bit

## ANTENNA MOUNTING

The best mounting location for the antenna is in the center of a large, flat conductive surface. In almost all vehicles, these requirements are best satisfied by mounting the antenna at the center of the roof. Some vehicles have a large trunk lid that provides a good antenna location. If the trunk lid is used, connect grounding straps between the trunk lid and vehicle chassis to insure the trunk lid is at chassis ground. See the instruction manual supplied with the antenna for complete installation information.

## RADIO MOUNTING

### Non-Locking Trunnion/High Power Sleeve

The standard non-locking trunnion (or sleeve used on high power 800 MHz or lowband models) allows the radio to be mounted to a variety of mounting surfaces. Be sure the mounting surface is able to adequately support the weight of the radio. Allow sufficient space around the radio for free air flow for cooling. Be sure the unit is close enough to the vehicle operator to permit easy access to operating controls. Although the trunnion can be mounted to a plastic dashboard, it is recommended that the mounting screws be located so they penetrate the supporting metal frame of the dashboard.

## Floor Mount

A floor mount wedge is available which allows the radio to be tilted at either 45 or 60 degrees. The sleeve mounting hardware which is standard with lowband and 35 Watt 800 Mhz models mates with this wedge. If the wedge is to be used with other models, the sleeve must be ordered separately.

### Extra Stability Mounting Tray

The optional extra stability mounting tray is used in conjunction with the non-locking trunnion. If the radio is mounted on a rounded surface, you may need to supply and install shim washers (not provided) between the bracket and the mounting surface. Shims are necessary to tilt the radio because the heavy duty bracket blocks the standard trunnion adjustments. Follow instructions provided with the option.

**Note:** The extra stability mounting tray is not necessary for lowband and 800 MHz 35 Watt models as the sleeve mounting already provides maximum stability.

## Locking Trunnion

The optional locking trunnion consists of a two-piece trunnion type mounting bracket equipped with a key lock and associated mounting screws and is designed to facilitate easy removal. The locking trunnion may be mounted on either metal or plastic surfaces, provided the mounting surface adequately supports the weight of the radio. Follow instructions provided with the option.

Before attempting to install the locking trunnion, examine the vehicle for suitable mounting locations. This bracket requires a flat mounting surface, 8" x 2" minimum with adequate clearance for inserting the radio. The chosen location should be convenient to the vehicle operator and provide access to the power and the antenna connectors. Be careful to choose a location that permits the locking trunnion to be removed from the mounting bracket. Vehicle operation should never be impaired by the location of the trunnion or radio.

The locking trunnion is not compatible with the lowband and 35 Watt 800 MHz models.

**Note:** Overhead mounting is not recommended.

## BEGIN INSTALLATION

### DC POWER CABLE INSTALLATION

This radio must be operated only in negative ground electrical systems. Reverse polarity does not damage the radio; however, radio protection circuits cause the cable fuse to open. Check the vehicle ground polarity before you begin installation to prevent wasted time and effort.

The 8-foot DC power cable shipped with the radio is long enough for installation in most vehicles. Begin the power cable installation in the following manner:

- (1) Determine a routing plan for the power cable with reference to where the radio is to be mounted.
- (2) Locate an existing hole with a grommet in the vehicle fire wall, or drill a 3/8" access hole at the location for passing the power cable into the engine compartment. Install a grommet with 1/4" I.D. in the access hole to avoid damage to the cable.

**CAUTION: HIGH DEGREE OF CARE SHOULD BE EXERCISED NOT TO DAMAGE ANY EXISTING VEHICLE WIRES.**

- (3) From inside the vehicle, feed the red and black leads (without lugs attached) through the access hole and into the engine compartment. See Figure 1.
- (4) Locate the nearest available vehicle chassis ground mounting point and shorten the black lead to remove excess cable length.
- (5) Install ring lugs (supplied) onto stripped end of power cable black lead, and onto stripped end of red lead on fuse holder as shown in Figure 2.
- (6) Locate the fuse holder as close to the battery as possible and away from any hot engine component. Mount the fuse holder using the provided mounting hole and dress wires as necessary. Connect the fuse holder red adapter lead plug to the mating receptacle on the red lead of the power cable as shown in Figure 2.
- (7) Connect the power cable black lead directly to the vehicle chassis ground.
- (8) Connect the power cable red lead from the fuse holder to the positive (+) battery terminal. Make sure the adapter cable is connected to the main power cable red lead.
- (9) Plug fuse into in-line fuse holder as shown in Figure 2.

**NOTE:** Failure to mount the red lead of the power cable kit directly to the battery may result in severe alternator whine interference and cause radio to revert to mode 1 each time the power is turned off.

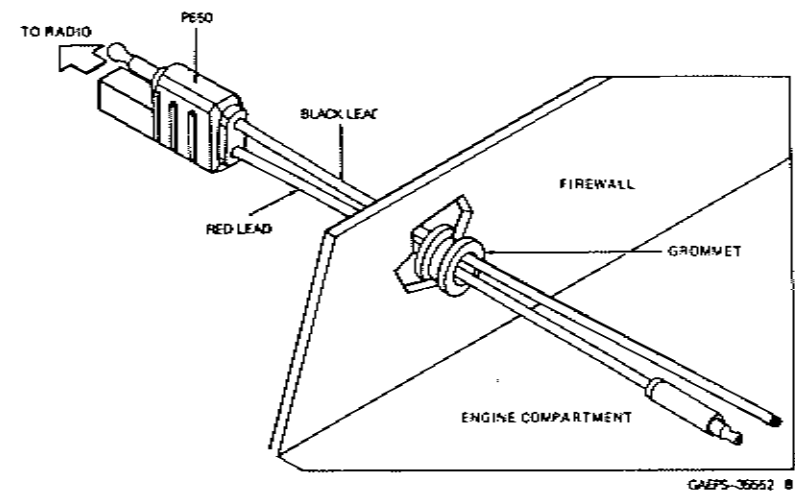

Figure 1. Power Cable Routing into Engine Compartment

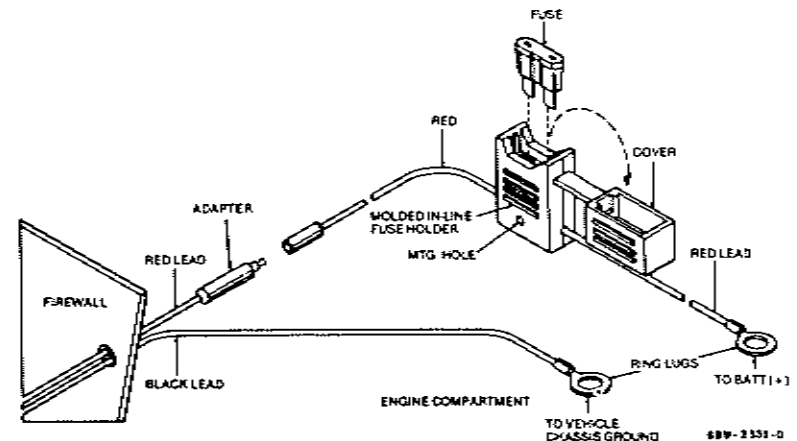

Figure 2. Power Cable Assembly

## NON-LOCKING TRUNNION INSTALLATION (See Figure 4)

- (1) Select the location to mount your radio either on the TRANSMISSION HUMP OR UNDER THE DASH (see Figure 4).
- (2) Using the trunnion mounting bracket as a template, mark the positions of the holes on the mounting surface. Use the innermost four holes for a curved mounting surface such as the transmission hump, and the four outmost holes for a flat surface such as under the dash.
- (3) Centerpunch the spots you have marked and drill a 5/32" hole at each.
- (4) Secure the trunnion mounting bracket to the surface with the four (10-16x3/4") screws provided.
- (5) Place the radio in the trunnion mounting bracket and secure it with the two thumb screws provided.
- (6) To complete your radio installation plug the power cable into the radio power connector (see Figure 3).
- (7) Mount the antenna using the instructions provided with the antenna kit. Run the coaxial cable to the radio mounting location. If necessary, cut off the access cable and install the cable connector.
- (8) Connect the antenna cable connector to the radio antenna connector on the rear of the radio (see Figure 3).
- (9) Mount the microphone clip. Follow instructions provided with the microphone clip.
- (10) Plug the Microphone into the front panel connector. Your microphone has a telephone type connector at the end of its cord. Connect and disconnect your Radio Microphone in the same manner you connect and disconnect your telephone handset.

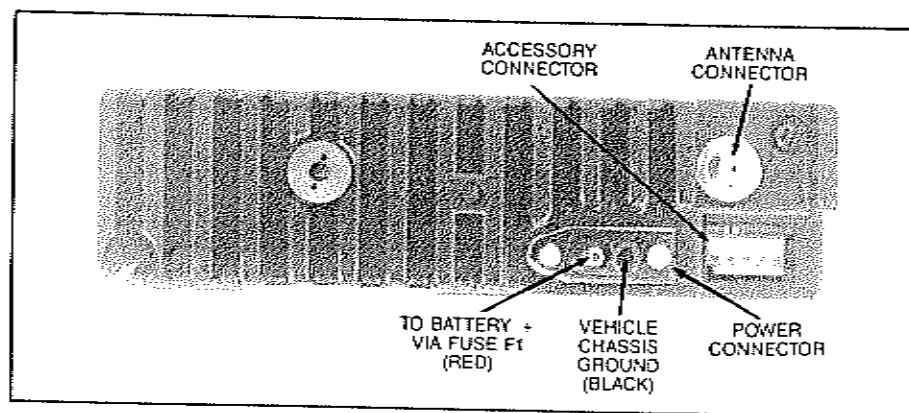

Figure 3. Connections to Radio Rear Panel

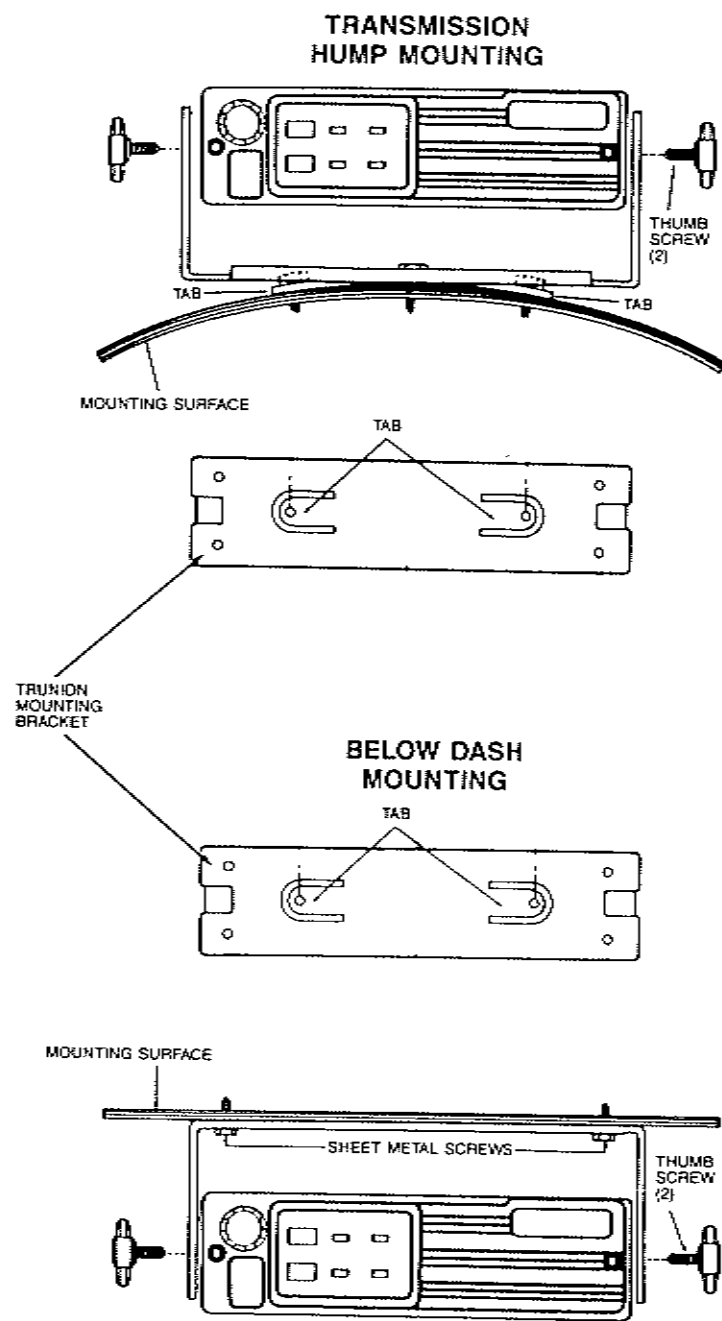

Figure 4. Trunnion Mount for Radio

## SLEEVE MOUNTING BRACKET INSTALLATION

(See Figure 5)

Your High Power Lowband and 800 MHz radios utilize a specially designed three point sleeve mounting bracket for on or under dash mounting. To mount your Radio on the floor an optional accessory, the Mounting Wedge, is available. (Kit No. HLN9450).

Dash mount your radio as follows:

- (1) Select the location to mount your radio either ON or UNDER DASH (see Figure 5).
- (2) Using the sleeve mounting bracket as a template, mark the positions of the holes on the mounting surface.
- (3) Centerpunch the spots you have marked and drill a 5/32" hole at each.
- (4) Secure the sleeve mounting bracket to the surface with the four (10-16x3/4) screws provided.
- (5) If there is sufficient room in the rear of the bracket to install the M5.0x10mm screw proceed with step (7).
- (6) Install the tapered stud and nut in the rear hole of the sleeve mounting bracket as shown in Figure 5.
- (7) Insert the radio into the sleeve mounting bracket guiding the tapered pin into the hole in the rear of the heatsink, and secure it with the two thumb screws provided. If you have skipped step 6 above, install the M5x0.8x10mm Torx screw in the rear of the bracket to secure the radio.
- (8) To complete your radio installation, plug the power cable into the radio power connector. Mount the antenna using the instructions provided with the antenna kit. Run the coaxial cable to the radio mounting location. If necessary, cut off the access cable and install the cable connector.
- (9) Connect the antenna cable connector to the radio antenna connector on the rear of the radio.
- (10) Mount the microphone clip. Follow instructions provided with the microphone clip.
- (11) Plug the Microphone into the front panel connector. Your microphone has a telephone type connector at the end of its cord. Connect and disconnect your Radio Microphone in the same manner you connect and disconnect a telephone handset.

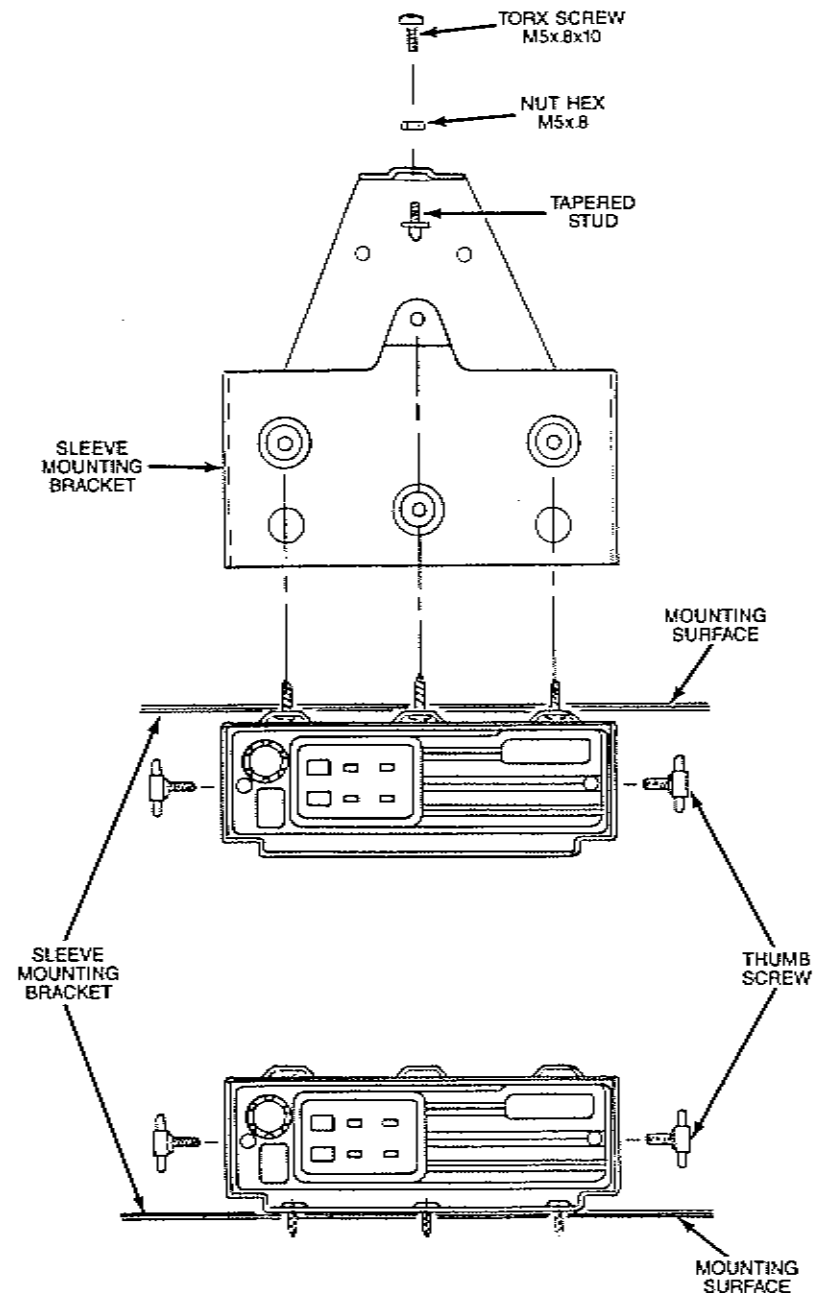



Figure 5. Sleeve Mount for Radio



## COMPUTER SOFTWARE COPYRIGHTS

The Motorola products described in this instruction manual include copyrighted Motorola computer programs stored in semiconductor memories or other mediums. Laws in the United States and other countries preserve for Motorola certain exclusive rights for copyrighted computer programs, including the exclusive right to copy or reproduce in any form the copyrighted computer program. Accordingly, any copyrighted Motorola computer programs contained in the Motorola products described in this instruction manual may not be copied or reproduced in any manner without the express written permission of Motorola. Furthermore, the purchase of Motorola products shall not be deemed to grant either directly or by implication, estoppel, or otherwise, any license under the copyrights, patents, or patent applications of Motorola, except for the normal non-exclusive, royalty fee license to use that arises by operation of law in the sale of a product.

11

 MOTOROLA, Radius, "RapidCall", "Private Line", "Digital Private Line" and "Touch Code" are trademarks of Motorola, Inc.  
© MOTOROLA, INC. 1990  
PRINTED IN U.S.A.

68-80901Z47-0