

Circuit Diagram

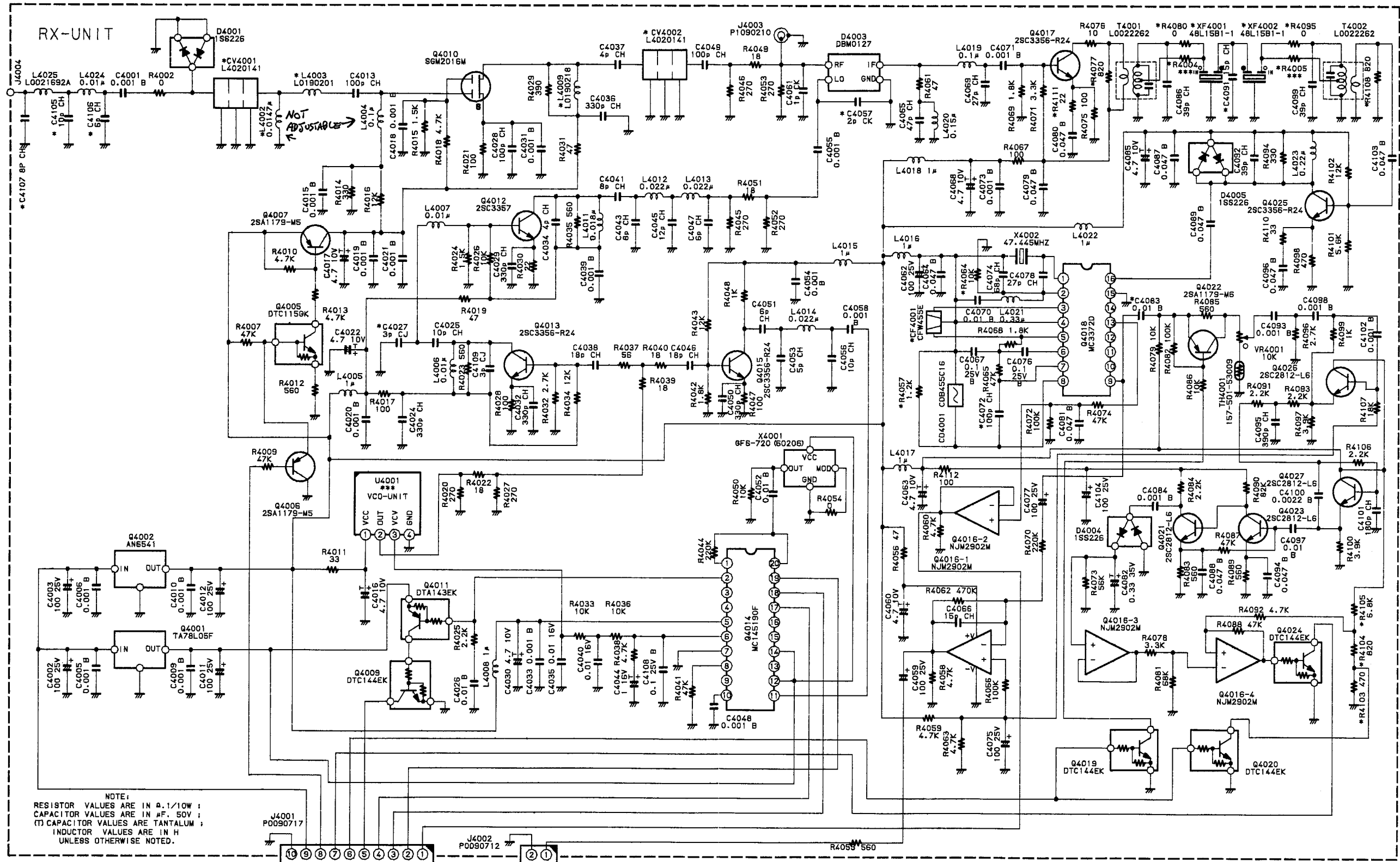

NOTE:
 RESISTOR VALUES ARE IN Ω, 1/10Ω;
 CAPACITOR VALUES ARE IN μF, 50V;
 (T) CAPACITOR VALUES ARE TANTALUM;
 INDUCTOR VALUES ARE IN H
 UNLESS OTHERWISE NOTED.

J4001 P0090717
 J4002 P0090712
 GND
 +13.8V
 RX OFF
 NSQ DET
 SIG LOW
 RX UL
 RX EN
 CLK
 DATA
 S-OUT
 GND
 DISC OUT

AUDIO
 OUT

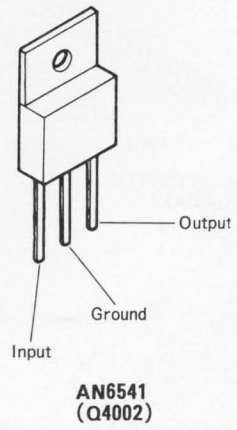
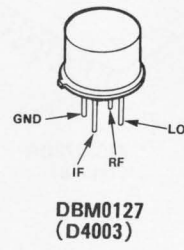

Parts Layout

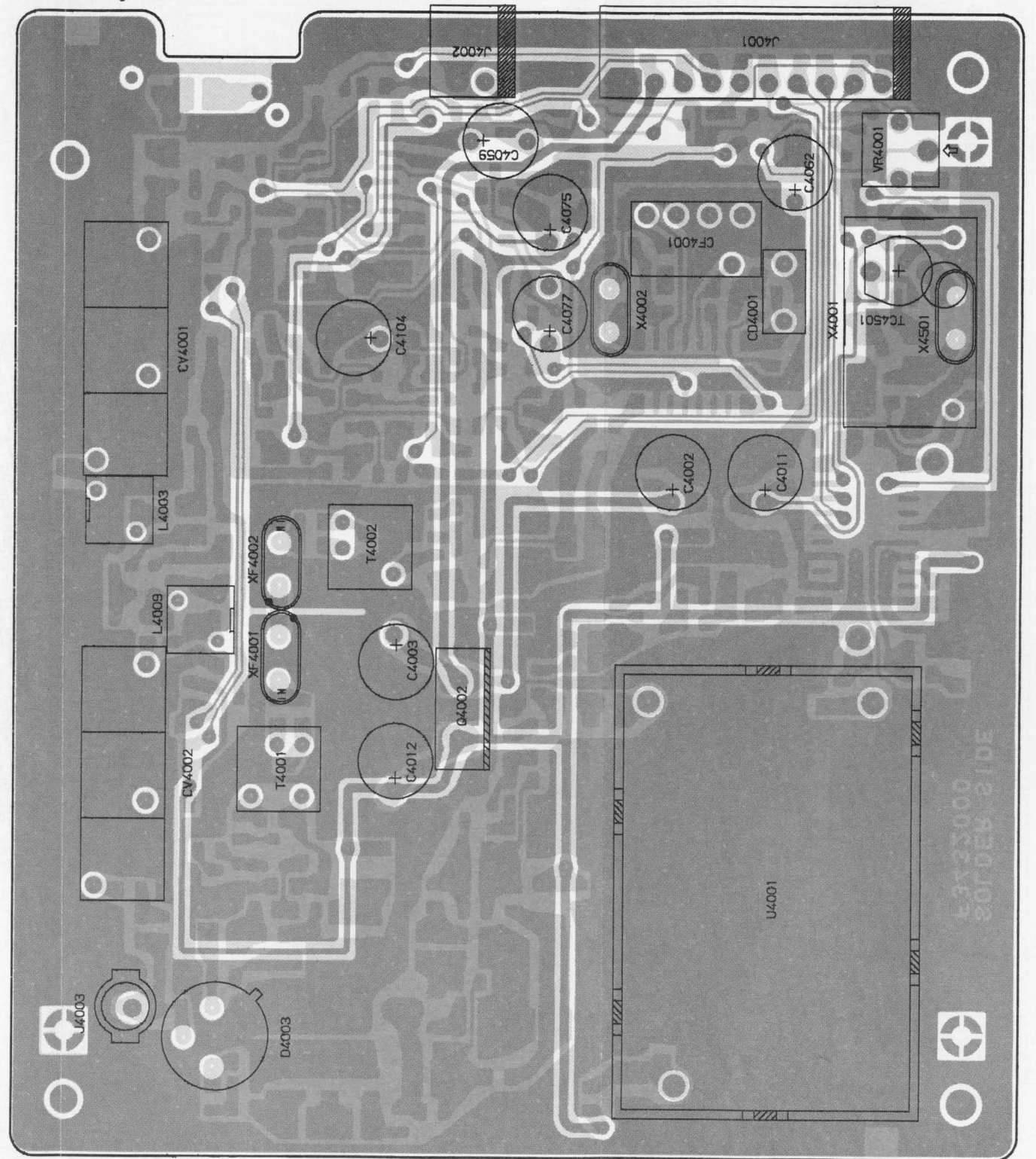

obverse view of component side

Parts Layout

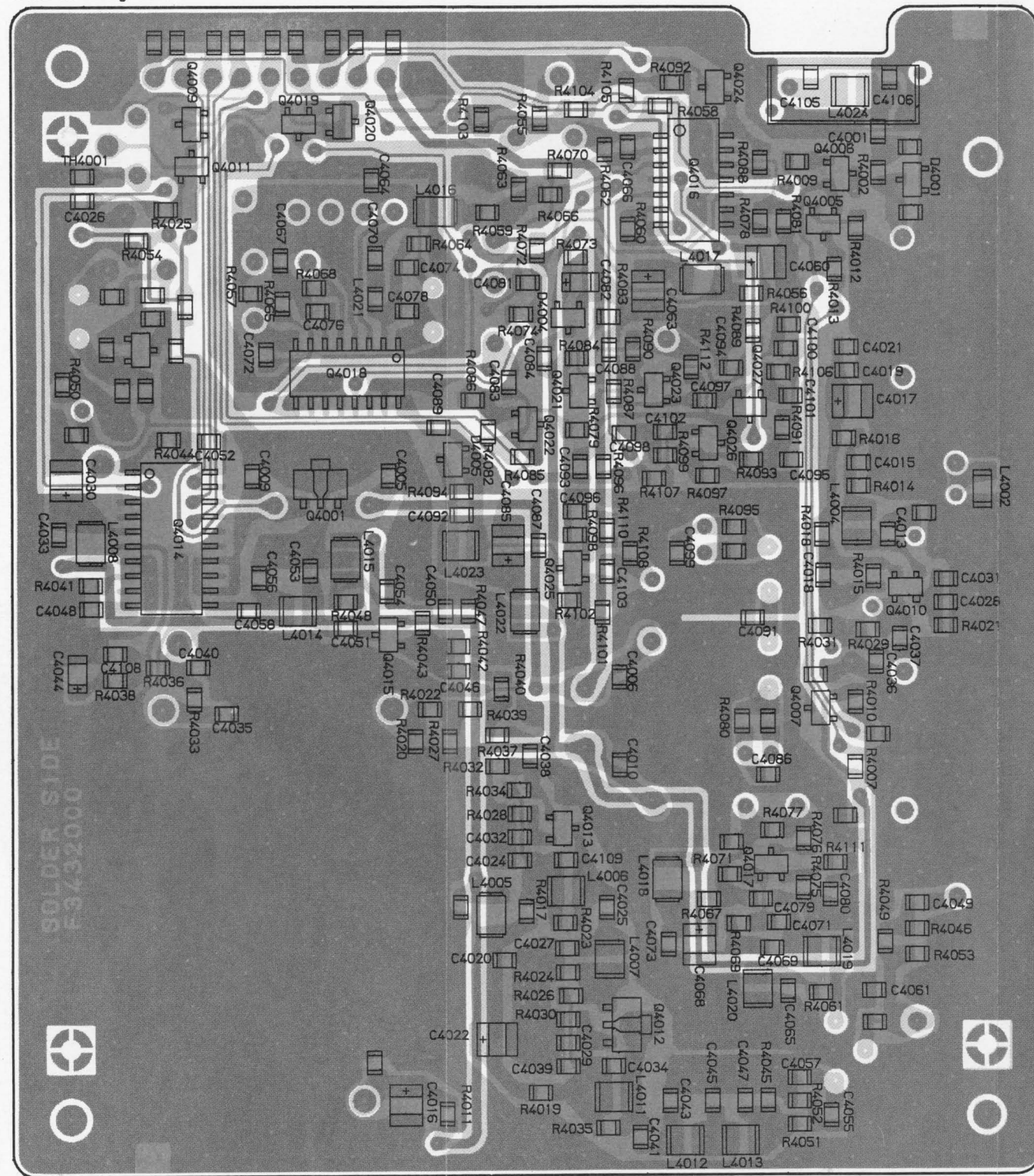

obverse view of chip side

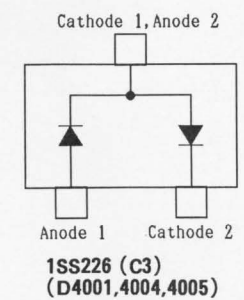
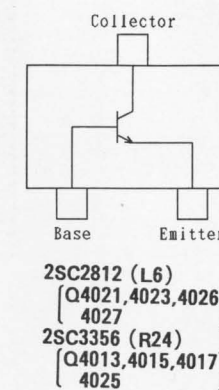
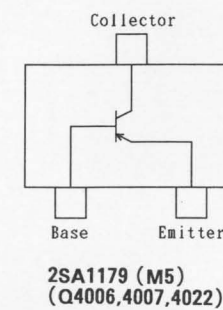
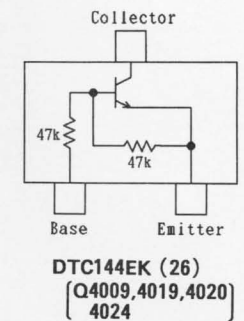
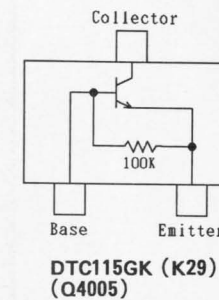
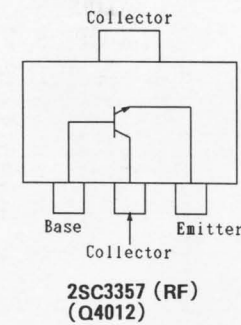
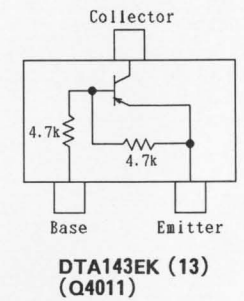
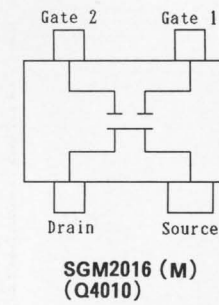
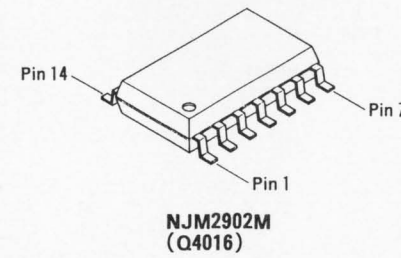
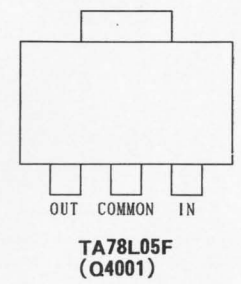
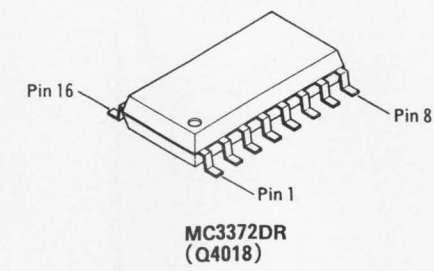
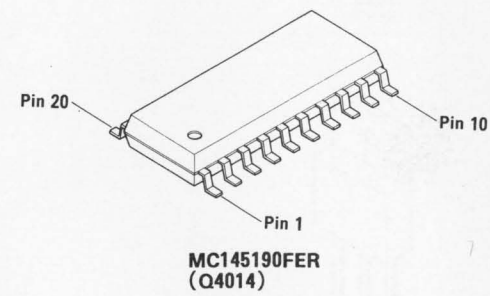

REF.	DESCRIPTION	VALUE	WV	TOL.	MFGR'S DESIG	YAESU P/N	VERS.	LOT.
*** RX UNIT ***								
	P.C.B. with Components (W/O RX VCO UNIT, J4004 CONNECTOR, SHIELD CASE, SHIELD FRAME, SHIELD COVER (2pcs), SPECIAL NUT, LEAF SPRING, STICK FINGER)					CA1253001 D, 25K		
						CA1253002 D, 20K	4-	
						CA1253003 D, 12.5K	4-	
						CA1253004 E, 25K	4-	
						CA1253005 E, 20K	4-	
						CA1253006 E, 12.5K	4-	
						CA1253007 F, 25K	4-	
						CA1253008 F, 20K	4-	
						CA1253009 F, 12.5K	4-	
						CA1253010 C, 25K	5-	
						CA1253011 C, 20K	5-	
						CA1253012 C, 12.5K	5-	
						CA1253013 A, 25K	5-	
						CA1253014 A, 20K	5-	
						CA1253015 A, 12.5K	5-	
	P.C.B. with Components (W/O J4004 CONNECTOR, SHIELD CASE, SHIELD FRAME, LEAF SPRING, SHIELD COVER, SPECIAL NUT (4pcs), STICK FINGER (2pcs), , C4107 CERAMIC CAP.)					CS1357001 D, 25K		
						CS1357002 D, 20K	4-	
						CS1357003 D, 12.5K	4-	
						CS1357004 E, 25K	4-	
						CS1357005 E, 20K	4-	
						CS1357006 E, 12.5K	4-	
						CS1357007 F, 25K	4-	
						CS1357008 F, 20K	4-	
						CS1357009 F, 12.5K	4-	
						CS1357010 C, 25K	5-	
						CS1357011 C, 20K	5-	
						CS1357012 C, 12.5K	5-	
						CS1357013 A, 25K	5-	
						CS1357014 A, 20K	5-	
						CS1357015 A, 12.5K	5-	
	Printed Circuit Board					F3432000		
C 4001	CHIP CAP.	0.001uF	50V	B	GRM40B102M50PT	K22170805		
C 4002	AL. ELECTRO. CAP.	100uF	25V		25V101M6X11TR5	K46140005		
C 4003	AL. ELECTRO. CAP.	100uF	25V		25V101M6X11TR5	K46140005		
C 4005	CHIP CAP.	0.001uF	50V	B	GRM40B102M50PT	K22170805		
C 4006	CHIP CAP.	0.001uF	50V	B	GRM40B102M50PT	K22170805		
C 4009	CHIP CAP.	0.001uF	50V	B	GRM40B102M50PT	K22170805		
C 4010	CHIP CAP.	0.001uF	50V	B	GRM40B102M50PT	K22170805		
C 4011	AL. ELECTRO. CAP.	100uF	25V		25V101M6X11TR5	K46140005		
C 4012	AL. ELECTRO. CAP.	100uF	25V		25V101M6X11TR5	K46140005		
C 4013	CHIP CAP.	100pF	50V	CH	GRM40CH101J50PT	K22170235		
C 4015	CHIP CAP.	0.001uF	50V	B	GRM40B102M50PT	K22170805		
C 4016	TANTALUM CHIP CAP.	4.7uF	10V		TESVB21A475M8R	K78100010		
C 4017	TANTALUM CHIP CAP.	4.7uF	10V		TESVB21A475M8R	K78100010		
C 4018	CHIP CAP.	0.001uF	50V	B	GRM40B102M50PT	K22170805		
C 4019	CHIP CAP.	0.001uF	50V	B	GRM40B102M50PT	K22170805		
C 4020	CHIP CAP.	0.001uF	50V	B	GRM40B102M50PT	K22170805		

REF.	DESCRIPTION	VALUE	WV	TOL.	MFR'S DESIG	YAESU P/N	VERS.	LOT.
C 4021	CHIP CAP.	0.001uF	50V	B	GRM40B102M50PT	K22170805		
C 4022	TANTALUM CHIP CAP.	4.7uF	10V		TESVB21A475M8R	K78100010		
C 4024	CHIP CAP.	330pF	50V	CH	GRM40CH331J50PT	K22170247		
C 4025	CHIP CAP.	10pF	50V	CH	GRM40CH100D50PT	K22170211		
C 4026	CHIP CAP.	0.01uF	50V	B	GRM40B103M50PT	K22170817		
C 4027	CHIP CAP.	8pF	50V	CH	GRM40CH080D50PT	K22170209	TYP A	5-
C 4027	CHIP CAP.	3pF	50V	CJ	GRM40CJ030C50PT	K22170204	TYP C	5-
C 4027	CHIP CAP.	3pF	50V	CJ	GRM40CJ030C50PT	K22170204	TYP D	
C 4027	CHIP CAP.	3pF	50V	CJ	GRM40CJ030C50PT	K22170204	TYP E	5-
C 4027	CHIP CAP.	3pF	50V	CJ	GRM40CJ030C50PT	K22170204	TYP F	5-
C 4028	CHIP CAP.	100pF	50V	CH	GRM40CH101J50PT	K22170235		
C 4029	CHIP CAP.	330pF	50V	CH	GRM40CH331J50PT	K22170247		
C 4030	TANTALUM CHIP CAP.	4.7uF	10V		TESVB21A475M8R	K78100010		
C 4031	CHIP CAP.	0.001uF	50V	B	GRM40B102M50PT	K22170805		
C 4032	CHIP CAP.	330pF	50V	CH	GRM40CH331J50PT	K22170247		
C 4033	CHIP CAP.	0.001uF	50V	B	GRM40B102M50PT	K22170805		
C 4034	CHIP CAP.	4pF	50V	CH	GRM40CH040C50PT	K22170205		
C 4035	FILM CAP.	0.01	16V		ECHU1C103JB5	K57120007		
C 4036	CHIP CAP.	330pF	50V	CH	GRM40CH331J50PT	K22170247		
C 4037	CHIP CAP.	4pF	50V	CH	GRM40CH040C50PT	K22170205		
C 4038	CHIP CAP.	18pF	50V	CH	GRM40CH180J50PT	K22170217		
C 4039	CHIP CAP.	0.001uF	50V	B	GRM40B102M50PT	K22170805		
C 4040	FILM CAP.	0.01	16V		ECHU1C103JB5	K57120007		
C 4041	CHIP CAP.	8pF	50V	CH	GRM40CH080D50PT	K22170209		
C 4043	CHIP CAP.	8pF	50V	CH	GRM40CH080D50PT	K22170209		
C 4044	TANTALUM CHIP CAP.	1uF	16V		TESVA1C105M1-8R	K78120009		
C 4045	CHIP CAP.	12pF	50V	CH	GRM40CH120J50PT	K22170213		
C 4046	CHIP CAP.	18pF	50V	CH	GRM40CH180J50PT	K22170217		
C 4047	CHIP CAP.	6pF	50V	CH	GRM40CH060D50PT	K22170207		
C 4048	CHIP CAP.	0.001uF	50V	B	GRM40B102M50PT	K22170805		
C 4049	CHIP CAP.	100pF	50V	CH	GRM40CH101J50PT	K22170235		
C 4050	CHIP CAP.	330pF	50V	CH	GRM40CH331J50PT	K22170247		
C 4051	CHIP CAP.	6pF	50V	CH	GRM40CH060D50PT	K22170207		
C 4052	CHIP CAP.	0.01uF	50V	B	GRM40B103M50PT	K22170817		
C 4053	CHIP CAP.	5pF	50V	CH	GRM40CH050C50PT	K22170206		
C 4054	CHIP CAP.	0.001uF	50V	B	GRM40B102M50PT	K22170805		
C 4055	CHIP CAP.	0.001uF	50V	B	GRM40B102M50PT	K22170805		
C 4056	CHIP CAP.	10pF	50V	CH	GRM40CH100D50PT	K22170211		
C 4057	CHIP CAP.	2pF	50V	CK	GRM40CK020C50PT	K22170203	TYP D	
C 4058	CHIP CAP.	0.001uF	50V	B	GRM40B102M50PT	K22170805		
C 4059	AL. ELECTRO. CAP.	100uF	25V		25V101M6X11TR5	K46140005		
C 4060	TANTALUM CHIP CAP.	4.7uF	10V		TESVB21A475M8R	K78100010		
C 4061	CHIP CAP.	1pF	50V	CK	GRM40CK010C50PT	K22170202		
C 4062	AL. ELECTRO. CAP.	100uF	25V		25V101M6X11TR5	K46140005		
C 4063	TANTALUM CHIP CAP.	4.7uF	10V		TESVB21A475M8R	K78100010		
C 4064	CHIP CAP.	0.047uF	50V	B	GRM40B473M50PT	K22170823		
C 4065	CHIP CAP.	47pF	50V	CH	GRM40CH470J50PT	K22170227		
C 4066	CHIP CAP.	15pF	50V	CH	GRM40CH150J50PT	K22170215		
C 4067	CHIP CAP.	0.1uF	25V	B	GRM40B104M25PT	K22140811		
C 4068	TANTALUM CHIP CAP.	4.7uF	10V		TESVB21A475M8R	K78100010		
C 4069	CHIP CAP.	27pF	50V	CH	GRM40CH270J50PT	K22170221		
C 4070	CHIP CAP.	0.01uF	50V	B	GRM40B103M50PT	K22170817		

RX UNIT

REF.	DESCRIPTION	VALUE	WV	TOL.	MFGR'S DESIG	YAESU P/N	VERS.	LOT.
C 4071	CHIP CAP.	0.001uF	50V	B	GRM40B102M50PT	K22170805		
C 4072	CHIP CAP.	120pF	50V	CH	GRM40CH121J50PT	K22170237	SEP 12.5	3-
C 4072	CHIP CAP.	100pF	50V	CH	GRM40CH101J50PT	K22170235	SEP 20	3-
C 4072	CHIP CAP.	100pF	50V	CH	GRM40CH101J50PT	K22170235	SEP 25	
C 4073	CHIP CAP.	0.001uF	50V	B	GRM40B102M50PT	K22170805		
C 4074	CHIP CAP.	68pF	50V	CH	GRM40CH680J50PT	K22170231		
C 4075	AL. ELECTRO. CAP.	100uF	25V		25V101M6X11TR5	K46140005		
C 4076	CHIP CAP.	0.1uF	25V	B	GRM40B104M25PT	K22140811		
C 4077	AL. ELECTRO. CAP.	100uF	25V		25V101M6X11TR5	K46140005		
C 4078	CHIP CAP.	27pF	50V	CH	GRM40CH270J50PT	K22170221		
C 4079	CHIP CAP.	0.047uF	50V	B	GRM40B473M50PT	K22170823		
C 4080	CHIP CAP.	0.047uF	50V	B	GRM40B473M50PT	K22170823		
C 4081	CHIP CAP.	0.047uF	50V	B	GRM40B473M50PT	K22170823		
C 4082	TANTALUM CHIP CAP.	0.33uF	35V		TESVA1V334M1-8R	K78160028		
C 4083	CHIP CAP.	0.001uF	50V	B	GRM40B102M50PT	K22170805	SEP 12.5	3-
C 4083	CHIP CAP.	0.01uF	50V	B	GRM40B103M50PT	K22170817	SEP 20	3-
C 4083	CHIP CAP.	0.01uF	50V	B	GRM40B103M50PT	K22170817	SEP 25	
C 4084	CHIP CAP.	0.001uF	50V	B	GRM40B102M50PT	K22170805		
C 4085	TANTALUM CHIP CAP.	4.7uF	10V		TESVB21A475M8R	K78100010		
C 4086	CHIP CAP.	39pF	50V	CH	GRM40CH390J50PT	K22170225		
C 4087	CHIP CAP.	0.047uF	50V	B	GRM40B473M50PT	K22170823		
C 4088	CHIP CAP.	0.047uF	50V	B	GRM40B473M50PT	K22170823		
C 4089	CHIP CAP.	0.047uF	50V	B	GRM40B473M50PT	K22170823		
C 4091	CHIP CAP.	22pF	50V	CH	GRM40CH220J50PT	K22170219	SEP 12.5	3-
C 4091	CHIP CAP.	27pF	50V	CH	GRM40CH270J50PT	K22170221	SEP 20	3-
C 4091	CHIP CAP.	15pF	50V	CH	GRM40CH150J50PT	K22170215	SEP 25	
C 4092	CHIP CAP.	39pF	50V	CH	GRM40CH390J50PT	K22170225		
C 4093	CHIP CAP.	0.001uF	50V	B	GRM40B102M50PT	K22170805		
C 4094	CHIP CAP.	0.047uF	50V	B	GRM40B473M50PT	K22170823		
C 4095	CHIP CAP.	390pF	50V	CH	GRM40CH391J50PT	K22170249		
C 4096	CHIP CAP.	0.047uF	50V	B	GRM40B473M50PT	K22170823		
C 4097	CHIP CAP.	0.01uF	50V	B	GRM40B103M50PT	K22170817		
C 4098	CHIP CAP.	0.001uF	50V	B	GRM40B102M50PT	K22170805		
C 4099	CHIP CAP.	39pF	50V	CH	GRM40CH390J50PT	K22170225		
C 4100	CHIP CAP.	0.0022uF	50V	B	GRM40B222M50PT	K22170809		
C 4101	CHIP CAP.	180pF	50V	CH	GRM40CH181J50PT	K22170241		
C 4102	CHIP CAP.	0.001uF	50V	B	GRM40B102M50PT	K22170805		
C 4103	CHIP CAP.	0.047uF	50V	B	GRM40B473M50PT	K22170823		
C 4104	AL. ELECTRO. CAP.	100uF	25V		25V101M6X11TR5	K46140005		
C 4105	CHIP CAP.	10pF	50V	CH	GRM40CH100D50PT	K22170211	TYP A	5-
C 4105	CHIP CAP.	12pF	50V	CH	GRM40CH120J50PT	K22170213	TYP C	5-
C 4105	CHIP CAP.	10pF	50V	CH	GRM40CH100D50PT	K22170211	TYP D	
C 4105	CHIP CAP.	10pF	50V	CH	GRM40CH100D50PT	K22170211	TYP E	5-
C 4105	CHIP CAP.	10pF	50V	CH	GRM40CH100D50PT	K22170211	TYP F	5-
C 4106	CHIP CAP.	6pF	50V	CH	GRM40CH060D50PT	K22170207	TYP A	5-
C 4106	CHIP CAP.	7pF	50V	CH	GRM40CH070D50PT	K22170208	TYP C	5-
C 4106	CHIP CAP.	6pF	50V	CH	GRM40CH060D50PT	K22170207	TYP D	
C 4106	CHIP CAP.	6pF	50V	CH	GRM40CH060D50PT	K22170207	TYP E	5-
C 4106	CHIP CAP.	6pF	50V	CH	GRM40CH060D50PT	K22170207	TYP F	5-
C 4107	CERAMIC CAP.	8pF	50V	CH	DD104CH080D50	K02173080	TYP A	5-
C 4107	CERAMIC CAP.	8pF	50V	CH	DD104CH080D50	K02173080	TYP C	5-
C 4107	CERAMIC CAP.	8pF	50V	CH	DD104CH080D50	K02173080	TYP D	

REF.	DESCRIPTION	VALUE	WV	TOL.	MFGR'S DESIG	YAESU P/N	VERS.	LOT.
C 4107	CERAMIC CAP.	6pF	50V	CH	DD104CH060D50	K02173060	TYP E	3-
C 4107	CERAMIC CAP.	5pF	50V	CH	DD104CH050C50	K02172050	TYP F	3-
C 4108	CHIP CAP.	0.1uF	25V	B	GRM40B104M25PT	K22140811		
C 4109	CHIP CAP.	3pF	50V	CJ	GRM40CJ030C50PT	K22170204		
CD4001	CERAMIC DISC				CDB455C16	H7900740		
CF4001	CERAMIC FILTER				CFW455G	H3900392	SEP 12.5	3-
CF4001	CERAMIC FILTER				CFW455F	H3900202	SEP 20	3-
CF4001	CERAMIC FILTER				CFW455E	H3900200	SEP 25	
CV4001	HELICAL RESONATOR				7HT 410M	L4020144	TYP A	5-
CV4001	HELICAL RESONATOR				7HT 440M	L4020140	TYP C	5-
CV4001	HELICAL RESONATOR				7HT 460M	L4020141	TYP D	
CV4001	HELICAL RESONATOR				7HT 480M	L4020142	TYP E	3-
CV4001	HELICAL RESONATOR				7HT 500M	L4020145	TYP F	3-
CV4002	HELICAL RESONATOR				7HT 410M	L4020144	TYP A	5-
CV4002	HELICAL RESONATOR				7HT 440M	L4020140	TYP C	5-
CV4002	HELICAL RESONATOR				7HT 460M	L4020141	TYP D	
CV4002	HELICAL RESONATOR				7HT 480M	L4020142	TYP E	3-
CV4002	HELICAL RESONATOR				7HT 500M	L4020145	TYP F	3-
D 4001	DIODE				1SS226 TE85R	G2070003		
D 4003	DOUBLE-BALANCED-MIXER				DBM0127	Q7000196		
D 4004	DIODE				1SS226 TE85R	G2070003		
D 4005	DIODE				1SS226 TE85R	G2070003		
J 4001	CONNECTOR				SC25-10WL	P0090717		
J 4002	CONNECTOR				SC25-02WL	P0090712		
J 4003	CONNECTOR				TMP-J01X-V6	P1090210		
J 4004	CONNECTOR				BNC-RM-1	P1090773A		
L 4002	CHIP COIL	0.027u			LQN1A27NJ04	L1690253	TYP A	5-
L 4002	CHIP COIL	0.0147u			LQN1A15NJ04	L1690251	TYP C	5-
L 4002	CHIP COIL	0.0147u			LQN1A15NJ04	L1690251	TYP D	
L 4002	CHIP COIL	0.0088u			LQN1A8N8J04	L1690250	TYP F	3-
L 4003	COIL				MC139	L0190201	TYP A	5-
L 4003	COIL				MC139	L0190201	TYP C	5-
L 4003	COIL				MC139	L0190201	TYP D	
L 4003	COIL				MC139	L0190203	TYP E	3-
L 4003	COIL				MC139	L0190209	TYP F	3-
L 4004	CHIP COIL	0.1uH			LQN2AR10K	L1690011		
L 4005	M. RFC	1uH			FLC32T-1R0K	L1690203		
L 4006	CHIP COIL	0.01uH			LQN2A10NM	L1690001		
L 4007	CHIP COIL	0.01uH			LQN2A10NM	L1690001		
L 4008	M. RFC	1uH			FLC32T-1R0K	L1690203		
L 4009	COIL				MC139	L0190218	TYP A	5-
L 4009	COIL				MC139	L0190218	TYP C	5-
L 4009	COIL				MC139	L0190218	TYP D	
L 4009	COIL				MC139	L0190201	TYP E	3-
L 4009	COIL				MC139	L0190222	TYP F	3-
L 4011	CHIP COIL	0.018u			LQN2A18NM	L1690004		

RX UNIT

REF.	DESCRIPTION	VALUE	WV	TOL.	MFGR'S DESIG	YAESU P/N	VERS.	LOT.
L 4012	CHIP COIL	0.022uH			LQN2A22NM	L1690002		
L 4013	CHIP COIL	0.022uH			LQN2A22NM	L1690002		
L 4014	CHIP COIL	0.022uH			LQN2A22NM	L1690002		
L 4015	M. RFC	1uH			FLC32T-1R0K	L1690203		
L 4016	M. RFC	1uH			FLC32T-1R0K	L1690203		
L 4017	M. RFC	1uH			FLC32T-1R0K	L1690203		
L 4018	M. RFC	1uH			FLC32T-1R0K	L1690203		
L 4019	CHIP COIL	0.1uH			LQN2AR10K	L1690011		
L 4020	CHIP COIL	0.15uH			LQN2AR15K	L1690013		
L 4021	M. RFC	0.33uH			LK2125 R33K-T	L1690313		
L 4022	M. RFC	1uH			FLC32T-1R0K	L1690203		
L 4023	CHIP COIL	0.22uH			LQN2AR22K	L1690003		
L 4024	CHIP COIL	0.01uH			LQN2A10NM	L1690001		
L 4025	COIL				1.5T3.0DO.6UEW R	L0021810A		
Q 4001	IC				TA78L05F TE12R	G1091014		
Q 4002	IC				AN6541	G1091146		
Q 4005	TRANSISTOR				DTC115GK T146	G3070092		
Q 4006	TRANSISTOR				2SA1179M5-TA	G3111797E		
Q 4007	TRANSISTOR				2SA1179M5-TA	G3111797E		
Q 4009	TRANSISTOR				DTC144EK T147	G3070033		
Q 4010	FET				SGM2016M-T8	G4070005		
Q 4011	TRANSISTOR				DTA143EK T146	G3070010		
Q 4012	TRANSISTOR				2SC3357-T2	G3333577		
Q 4013	TRANSISTOR				2SC3356-T2B R24	G3333567D		
Q 4014	IC				MC145190FER	G1091621		
Q 4015	TRANSISTOR				2SC3356-T2B R24	G3333567D		
Q 4016	IC				NJM2902M-T2	G1090908		
Q 4017	TRANSISTOR				2SC3356-T2B R24	G3333567D		
Q 4018	IC				MC3372DR	G1091339		
Q 4019	TRANSISTOR				DTC144EK T147	G3070033		
Q 4020	TRANSISTOR				DTC144EK T147	G3070033		
Q 4021	TRANSISTOR				2SC2812L6-TA	G3328127F		
Q 4022	TRANSISTOR				2SA1179M6-TA	G3111797F		
Q 4023	TRANSISTOR				2SC2812L6-TA	G3328127F		
Q 4024	TRANSISTOR				DTC144EK T147	G3070033		
Q 4025	TRANSISTOR				2SC3356-T2B R24	G3333567D		
Q 4026	TRANSISTOR				2SC2812L6-TA	G3328127F		
Q 4027	TRANSISTOR				2SC2812L6-TA	G3328127F		
R 4002	CHIP RES.	68	1/10W	5%	RMC1/10T 680J	J24205680	SEP 12.5	3-
R 4002	CHIP RES.	0	1/10W	5%	RMC1/10T 000J	J24205000	SEP 12.5	5-
R 4002	CHIP RES.	0	1/10W	5%	RMC1/10T 000J	J24205000	SEP 20	3-
R 4002	CHIP RES.	0	1/10W	5%	RMC1/10T 000J	J24205000	SEP 25	
R 4003	CHIP RES.	100	1/10W	5%	RMC1/10T 101J	J24205101	SEP 12.5	3-4
R 4004	CHIP RES.	0	1/10W	5%	RMC1/10T 000J	J24205000	SEP 12.5	3-
R 4004	CHIP RES.	0	1/10W	5%	RMC1/10T 000J	J24205000	SEP 20	3-
R 4005	CHIP RES.	0	1/10W	5%	RMC1/10T 000J	J24205000	SEP 12.5	3-
R 4005	CHIP RES.	0	1/10W	5%	RMC1/10T 000J	J24205000	SEP 20	3-
R 4007	CHIP RES.	47K	1/10W	5%	RMC1/10T 473J	J24205473		
R 4009	CHIP RES.	47K	1/10W	5%	RMC1/10T 473J	J24205473		
R 4010	CHIP RES.	4.7K	1/10W	5%	RMC1/10T 472J	J24205472		

REF.	DESCRIPTION	VALUE	WV	TOL.	MFRG'S DESIG	YAESU P/N	VERS.	LOT.
R 4011	CHIP RES.	33	1/10W	5%	RMC1/10T 330J	J24205330		
R 4012	CHIP RES.	560	1/10W	5%	RMC1/10T 561J	J24205561		
R 4013	CHIP RES.	4.7K	1/10W	5%	RMC1/10T 472J	J24205472		
R 4014	CHIP RES.	330	1/10W	5%	RMC1/10T 331J	J24205331		
R 4015	CHIP RES.	1.5K	1/10W	5%	RMC1/10T 152J	J24205152		
R 4016	CHIP RES.	12K	1/10W	5%	RMC1/10T 123J	J24205123		
R 4017	CHIP RES.	100	1/10W	5%	RMC1/10T 101J	J24205101		
R 4018	CHIP RES.	4.7K	1/10W	5%	RMC1/10T 472J	J24205472		
R 4019	CHIP RES.	47	1/10W	5%	RMC1/10T 470J	J24205470		
R 4020	CHIP RES.	270	1/10W	5%	RMC1/10T 271J	J24205271		
R 4021	CHIP RES.	100	1/10W	5%	RMC1/10T 101J	J24205101		
R 4022	CHIP RES.	18	1/10W	5%	RMC1/10T 180J	J24205180		
R 4023	CHIP RES.	560	1/10W	5%	RMC1/10T 561J	J24205561		
R 4024	CHIP RES.	1.5K	1/10W	5%	RMC1/10T 152J	J24205152		
R 4025	CHIP RES.	2.2K	1/10W	5%	RMC1/10T 222J	J24205222		
R 4026	CHIP RES.	10K	1/10W	5%	RMC1/10T 103J	J24205103		
R 4027	CHIP RES.	270	1/10W	5%	RMC1/10T 271J	J24205271		
R 4028	CHIP RES.	100	1/10W	5%	RMC1/10T 101J	J24205101		
R 4029	CHIP RES.	390	1/10W	5%	RMC1/10T 391J	J24205391		
R 4030	CHIP RES.	22	1/10W	5%	RMC1/10T 220J	J24205220		
R 4031	CHIP RES.	47	1/10W	5%	RMC1/10T 470J	J24205470		
R 4032	CHIP RES.	2.7K	1/10W	5%	RMC1/10T 272J	J24205272		
R 4033	CHIP RES.	10K	1/10W	5%	RMC1/10T 103J	J24205103		
R 4034	CHIP RES.	12K	1/10W	5%	RMC1/10T 123J	J24205123		
R 4035	CHIP RES.	560	1/10W	5%	RMC1/10T 561J	J24205561		
R 4036	CHIP RES.	10K	1/10W	5%	RMC1/10T 103J	J24205103		
R 4037	CHIP RES.	56	1/10W	5%	RMC1/10T 560J	J24205560		
R 4038	CHIP RES.	4.7K	1/10W	5%	RMC1/10T 472J	J24205472		
R 4039	CHIP RES.	18	1/10W	5%	RMC1/10T 180J	J24205180		
R 4040	CHIP RES.	18	1/10W	5%	RMC1/10T 180J	J24205180		
R 4041	CHIP RES.	47K	1/10W	5%	RMC1/10T 473J	J24205473		
R 4042	CHIP RES.	1.8K	1/10W	5%	RMC1/10T 182J	J24205182		
R 4043	CHIP RES.	12K	1/10W	5%	RMC1/10T 123J	J24205123		
R 4044	CHIP RES.	220K	1/10W	5%	RMC1/10T 224J	J24205224		
R 4045	CHIP RES.	270	1/10W	5%	RMC1/10T 271J	J24205271		
R 4046	CHIP RES.	270	1/10W	5%	RMC1/10T 271J	J24205271		
R 4047	CHIP RES.	100	1/10W	5%	RMC1/10T 101J	J24205101		
R 4048	CHIP RES.	1K	1/10W	5%	RMC1/10T 102J	J24205102		
R 4049	CHIP RES.	18	1/10W	5%	RMC1/10T 180J	J24205180		
R 4050	CHIP RES.	10K	1/10W	5%	RMC1/10T 103J	J24205103		
R 4051	CHIP RES.	18	1/10W	5%	RMC1/10T 180J	J24205180		
R 4052	CHIP RES.	270	1/10W	5%	RMC1/10T 271J	J24205271		
R 4053	CHIP RES.	270	1/10W	5%	RMC1/10T 271J	J24205271		
R 4054	CHIP RES.	0	1/10W	5%	RMC1/10T 000J	J24205000		
R 4055	CHIP RES.	560	1/10W	5%	RMC1/10T 561J	J24205561		
R 4056	CHIP RES.	47	1/10W	5%	RMC1/10T 470J	J24205470		
R 4057	CHIP RES.	2.2K	1/10W	5%	RMC1/10T 222J	J24205222	SEP 12.5	3-
R 4057	CHIP RES.	1.5K	1/10W	5%	RMC1/10T 152J	J24205152	SEP 20	3-
R 4057	CHIP RES.	1.2K	1/10W	5%	RMC1/10T 122J	J24205122	SEP 25	
R 4058	CHIP RES.	4.7K	1/10W	5%	RMC1/10T 472J	J24205472		
R 4059	CHIP RES.	4.7K	1/10W	5%	RMC1/10T 472J	J24205472		
R 4060	CHIP RES.	4.7K	1/10W	5%	RMC1/10T 472J	J24205472		

REF.	DESCRIPTION	VALUE	WV	TOL.	MFGR'S DESIG	YAESU P/N	VERS.	LOT.
R 4061	CHIP RES.	47	1/10W	5%	RMC1/10T 470J	J24205470		
R 4062	CHIP RES.	470K	1/10W	5%	RMC1/10T 474J	J24205474		
R 4063	CHIP RES.	4. 7K	1/10W	5%	RMC1/10T 472J	J24205472		
R 4064	CHIP RES.	10K	1/10W	5%	RMC1/10T 103J	J24205103	TYP A	5-
R 4064	CHIP RES.	10K	1/10W	5%	RMC1/10T 103J	J24205103	TYP C	5-
R 4064	CHIP RES.	10K	1/10W	5%	RMC1/10T 103J	J24205103	TYP D	
R 4064	CHIP RES.	33K	1/10W	5%	RMC1/10T 333J	J24205333	TYP E	5-
R 4064	CHIP RES.	10K	1/10W	5%	RMC1/10T 103J	J24205103	TYP F	5-
R 4065	CHIP RES.	47K	1/10W	5%	RMC1/10T 473J	J24205473		
R 4066	CHIP RES.	100K	1/10W	5%	RMC1/10T 104J	J24205104		
R 4067	CHIP RES.	100	1/10W	5%	RMC1/10T 101J	J24205101		
R 4068	CHIP RES.	1. 8K	1/10W	5%	RMC1/10T 182J	J24205182		
R 4069	CHIP RES.	1. 8K	1/10W	5%	RMC1/10T 182J	J24205182		
R 4070	CHIP RES.	220K	1/10W	5%	RMC1/10T 224J	J24205224		
R 4071	CHIP RES.	3. 3K	1/10W	5%	RMC1/10T 332J	J24205332		
R 4072	CHIP RES.	100K	1/10W	5%	RMC1/10T 104J	J24205104		
R 4073	CHIP RES.	56K	1/10W	5%	RMC1/10T 563J	J24205563		
R 4074	CHIP RES.	47K	1/10W	5%	RMC1/10T 473J	J24205473		
R 4075	CHIP RES.	100	1/10W	5%	RMC1/10T 101J	J24205101		
R 4076	CHIP RES.	10	1/10W	5%	RMC1/10T 100J	J24205100		
R 4077	CHIP RES.	820	1/10W	5%	RMC1/10T 821J	J24205821	SEP 12. 5	3-
R 4077	CHIP RES.	1K	1/10W	5%	RMC1/10T 102J	J24205102	SEP 20	3-
R 4077	CHIP RES.	820	1/10W	5%	RMC1/10T 821J	J24205821	SEP 25	
R 4078	CHIP RES.	3. 3K	1/10W	5%	RMC1/10T 332J	J24205332		
R 4079	CHIP RES.	10K	1/10W	5%	RMC1/10T 103J	J24205103		
R 4080	CHIP RES.	0	1/10W	5%	RMC1/10T 000J	J24205000	SEP 25	
R 4081	CHIP RES.	68K	1/10W	5%	RMC1/10T 683J	J24205683		
R 4082	CHIP RES.	100K	1/10W	5%	RMC1/10T 104J	J24205104		
R 4083	CHIP RES.	560	1/10W	5%	RMC1/10T 561J	J24205561		
R 4084	CHIP RES.	2. 2K	1/10W	5%	RMC1/10T 222J	J24205222		
R 4085	CHIP RES.	560	1/10W	5%	RMC1/10T 561J	J24205561		
R 4086	CHIP RES.	10K	1/10W	5%	RMC1/10T 103J	J24205103		
R 4087	CHIP RES.	47K	1/10W	5%	RMC1/10T 473J	J24205473		
R 4088	CHIP RES.	47K	1/10W	5%	RMC1/10T 473J	J24205473		
R 4089	CHIP RES.	560	1/10W	5%	RMC1/10T 561J	J24205561		
R 4090	CHIP RES.	82K	1/10W	5%	RMC1/10T 823J	J24205823		
R 4091	CHIP RES.	2. 2K	1/10W	5%	RMC1/10T 222J	J24205222		
R 4092	CHIP RES.	4. 7K	1/10W	5%	RMC1/10T 472J	J24205472		
R 4093	CHIP RES.	2. 2K	1/10W	5%	RMC1/10T 222J	J24205222		
R 4094	CHIP RES.	330	1/10W	5%	RMC1/10T 331J	J24205331		
R 4095	CHIP RES.	0	1/10W	5%	RMC1/10T 000J	J24205000	SEP 25	
R 4096	CHIP RES.	2. 7K	1/10W	5%	RMC1/10T 272J	J24205272		
R 4097	CHIP RES.	3. 9K	1/10W	5%	RMC1/10T 392J	J24205392		
R 4098	CHIP RES.	470	1/10W	5%	RMC1/10T 471J	J24205471		
R 4099	CHIP RES.	1K	1/10W	5%	RMC1/10T 102J	J24205102		
R 4100	CHIP RES.	3. 9K	1/10W	5%	RMC1/10T 392J	J24205392		
R 4101	CHIP RES.	5. 6K	1/10W	5%	RMC1/10T 562J	J24205562		
R 4102	CHIP RES.	12K	1/10W	5%	RMC1/10T 123J	J24205123		
R 4103	CHIP RES.	390	1/10W	5%	RMC1/10T 391J	J24205391	SEP 12. 5	3-
R 4103	CHIP RES.	470	1/10W	5%	RMC1/10T 471J	J24205471	SEP 20	3-
R 4103	CHIP RES.	470	1/10W	5%	RMC1/10T 471J	J24205471	SEP 25	
R 4104	CHIP RES.	1K	1/10W	5%	RMC1/10T 102J	J24205102	SEP 12. 5	3-

RX UNIT

VXR-5000

REF.	DESCRIPTION	VALUE	WV	TOL.	MFGR'S DESIG	YAESU P/N	VERS.	LOT.
R 4104	CHIP RES.	820	1/10W	5%	RMC1/10T 821J	J24205821	SEP 20	3-
R 4104	CHIP RES.	820	1/10W	5%	RMC1/10T 821J	J24205821	SEP 25	
R 4105	CHIP RES.	3.3K	1/10W	5%	RMC1/10T 332J	J24205332	SEP 12.5	3-
R 4105	CHIP RES.	6.8K	1/10W	5%	RMC1/10T 682J	J24205682	SEP 20	3-
R 4105	CHIP RES.	6.8K	1/10W	5%	RMC1/10T 682J	J24205682	SEP 25	
R 4106	CHIP RES.	2.2K	1/10W	5%	RMC1/10T 222J	J24205222		
R 4107	CHIP RES.	18K	1/10W	5%	RMC1/10T 183J	J24205183		
R 4108	CHIP RES.	1K	1/10W	5%	RMC1/10T 102J	J24205102	SEP 12.5	3-
R 4108	CHIP RES.	1.2K	1/10W	5%	RMC1/10T 122J	J24205122	SEP 20	3-
R 4108	CHIP RES.	820	1/10W	5%	RMC1/10T 821J	J24205821	SEP 25	
R 4110	CHIP RES.	33	1/10W	5%	RMC1/10T 330J	J24205330		
R 4111	CHIP RES.	47	1/10W	5%	RMC1/10T 470J	J24205470	SEP 12.5	3-
R 4111	CHIP RES.	22	1/10W	5%	RMC1/10T 220J	J24205220	SEP 20	3-
R 4111	CHIP RES.	22	1/10W	5%	RMC1/10T 220J	J24205220	SEP 25	
R 4112	CHIP RES.	100	1/10W	5%	RMC1/10T 101J	J24205101		
T 4001	COIL				47.9M	L0022262		
T 4002	COIL				47.9M	L0022262		
TH4001	THERMISTOR				157-501-53009TP	G9090058		
VR4001	POT.	10K			EVN-DCAA03B14 10K	J50784103		
X 4001	XTAL				GFS-720 (60206)	H9500210		
X 4002	XTAL	47.445MHz				H0102981		
XF4001	XTAL				48L08B1-1	H1102178	SEP 12.5	3-
XF4001	XTAL				48L10B1-1	H1102179	SEP 20	3-
XF4001	XTAL				48L15B1-1	H1102180	SEP 25	
	LEAF SPRING					R0121430		
	SHIELD COVER					R0146300		
	SHIELD FRAME					R0147200		
	SHIELD CASE					R0519070A		
	SPECIAL NUT (4pcs)					R6068570		
	STICK FINGER (2pcs)				97-505-01 2BLOCK	S5000159		

RX UNIT