

Circuit Diagram

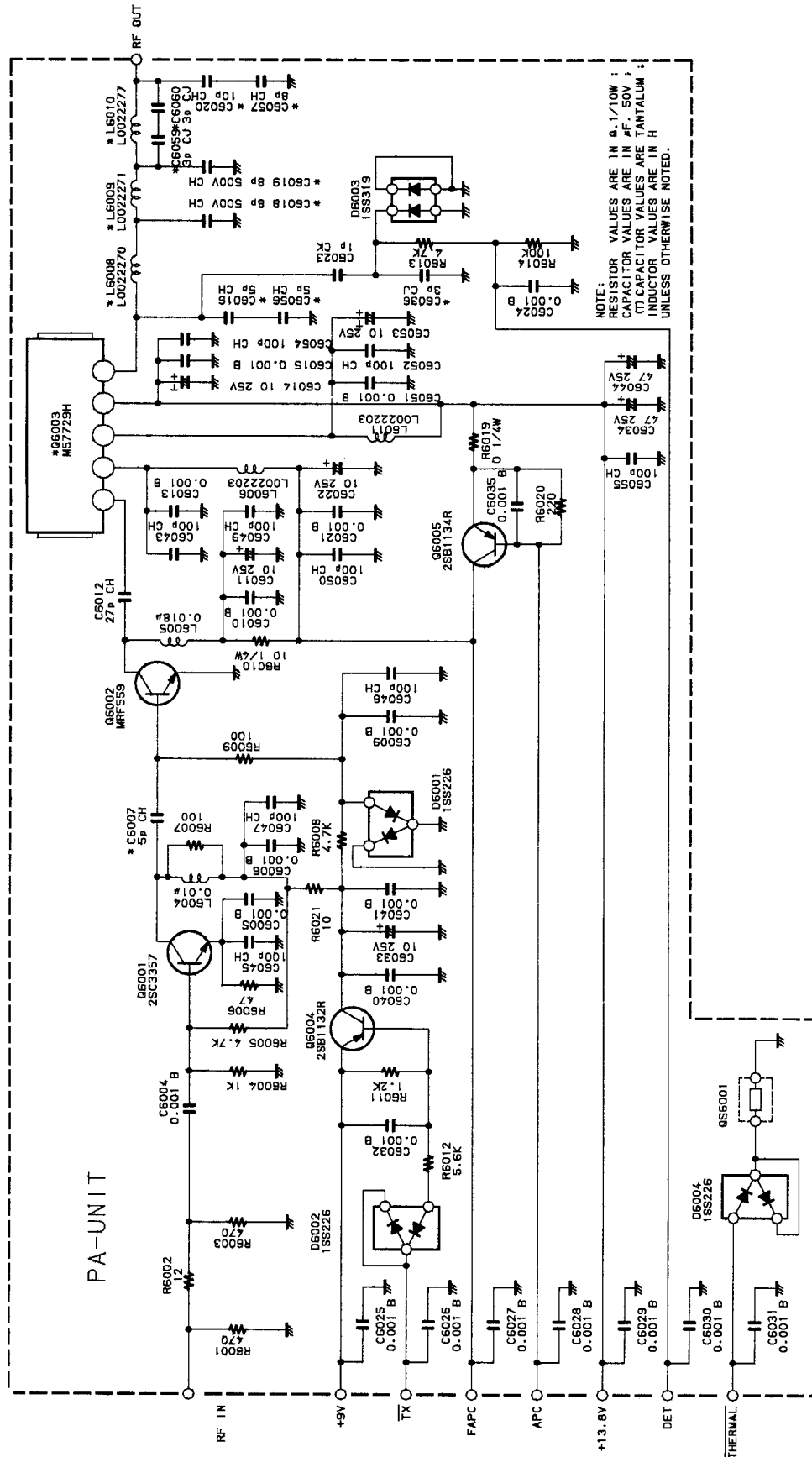

Parts Layout

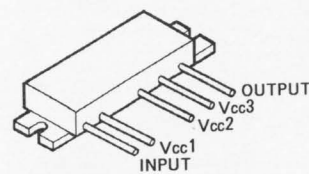
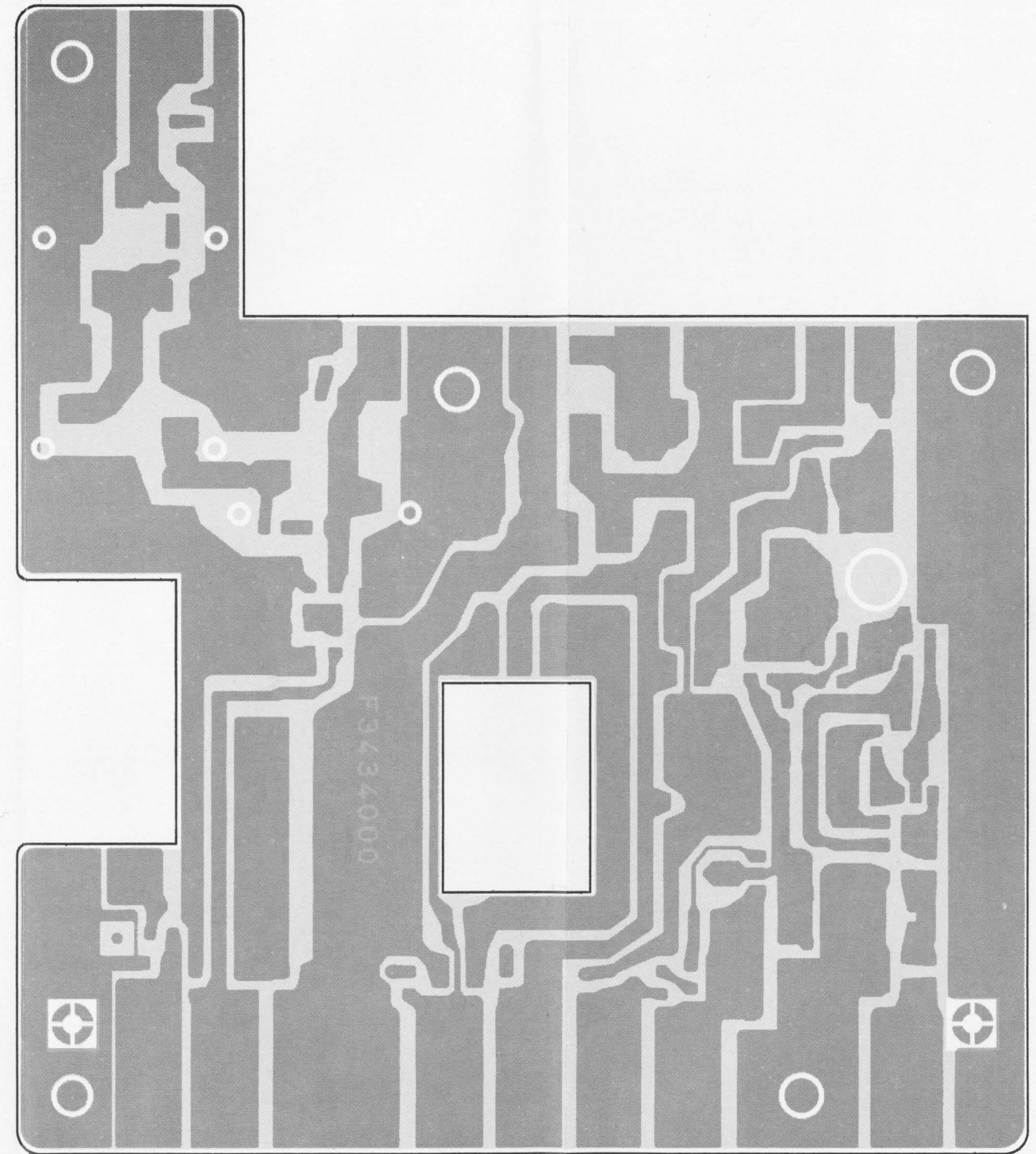
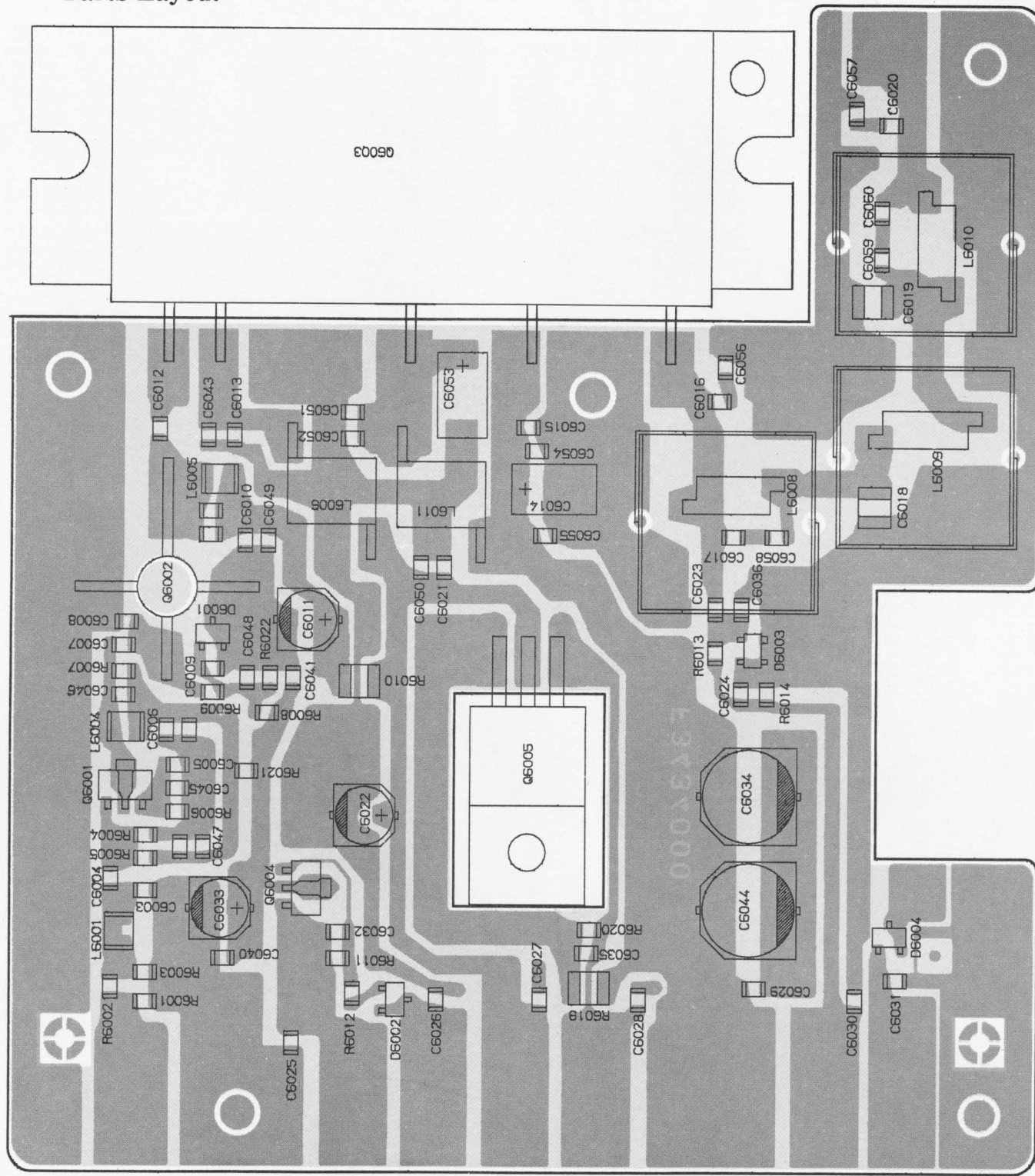

- M57729L Type A
- M57729 Type C
- M57729H Type D
- M57729UH Type E
- M57729SH Type F (Q6003)

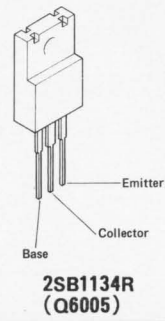

2SB1134R (Q6005)

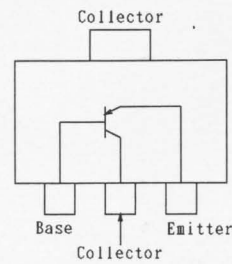

2SB1132 (Q6004)

obverse view of component side

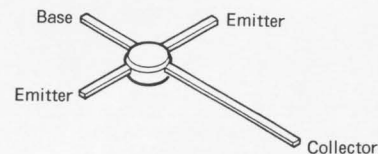

MRF559 (Q6002)

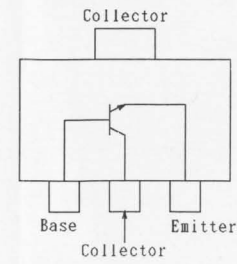

2SC3357 (RF) (Q6001)

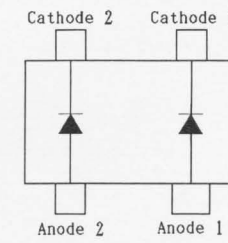

1SS319 (A4) (D6003)

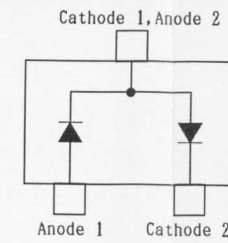

1SS226 (C3) (D6001, D6002, D6004)

obverse view of solder side

REF.	DESCRIPTION	VALUE	WV	TOL.	MFGR'S DESIG	YAESU P/N	VERS.	LOT.
*** PA UNIT ***								
	P.C.B. with Components					CS1358001	TYP D	
	P.C.B. with Components					CS1358002	TYP E	4-
	P.C.B. with Components					CS1358003	TYP F	4-
	P.C.B. with Components					CS1358004	TYP C	5-
	P.C.B. with Components					CS1358005	TYP A	5-
	Printed Circuit Board					F3434000		
C 6004	CHIP CAP.	0.001uF	50V	B	GRM40B102M50PT	K22170805		
C 6005	CHIP CAP.	0.001uF	50V	B	GRM40B102M50PT	K22170805		
C 6006	CHIP CAP.	0.001uF	50V	B	GRM40B102M50PT	K22170805		
C 6007	CHIP CAP.	8pF	50V	CH	GRM40CH080D50PT	K22170209	TYP A	5-
C 6007	CHIP CAP.	8pF	50V	CH	GRM40CH080D50PT	K22170209	TYP C	5-
C 6007	CHIP CAP.	5pF	50V	CH	GRM40CH050C50PT	K22170206	TYP D	
C 6007	CHIP CAP.	5pF	50V	CH	GRM40CH050C50PT	K22170206	TYP E	5-
C 6007	CHIP CAP.	5pF	50V	CH	GRM40CH050C50PT	K22170206	TYP F	5-
C 6009	CHIP CAP.	0.001uF	50V	B	GRM40B102M50PT	K22170805		
C 6010	CHIP CAP.	0.001uF	50V	B	GRM40B102M50PT	K22170805		
C 6011	AL. ELECTRO. CAP.	10uF	25V		ECEV1EV100SP	K48140003		
C 6012	CHIP CAP.	27pF	50V	CH	GRM40CH270J50PT	K22170221		
C 6013	CHIP CAP.	0.001uF	50V	B	GRM40B102M50PT	K22170805		
C 6014	TANTALUM CHIP CAP.	10uF	25V		TESVD1E106M12R	K78140018		
C 6015	CHIP CAP.	0.001uF	50V	B	GRM40B102M50PT	K22170805		
C 6016	CHIP CAP.	10pF	50V	CH	GRM40CH100D50PT	K22170211	TYP A	5-
C 6016	CHIP CAP.	6pF	50V	CH	GRM40CH060D50PT	K22170207	TYP C	5-
C 6016	CHIP CAP.	5pF	50V	CH	GRM40CH050C50PT	K22170206	TYP D	
C 6016	CHIP CAP.	10pF	50V	CH	GRM40CH100D50PT	K22170211	TYP E	5-
C 6016	CHIP CAP.	10pF	50V	CH	GRM40CH100D50PT	K22170211	TYP F	5-
C 6018	CHIP CAP.	8pF	500V	CH	GRM42-2CH080D500PT	K22275211	TYP A	5-
C 6018	CHIP CAP.	9pF	500V	CH	GRM42-2CH090J500PT	K22275212	TYP C	5-
C 6018	CHIP CAP.	8pF	500V	CH	GRM42-2CH080D500PT	K22275211	TYP D	
C 6018	CHIP CAP.	9pF	500V	CH	GRM42-2CH090J500PT	K22275212	TYP E	3-
C 6018	CHIP CAP.	9pF	500V	CH	GRM42-2CH090J500PT	K22275212	TYP F	3-
C 6019	CHIP CAP.	8pF	500V	CH	GRM42-2CH080D500PT	K22275211	TYP A	5-
C 6019	CHIP CAP.	9pF	500V	CH	GRM42-2CH090J500PT	K22275212	TYP C	5-
C 6019	CHIP CAP.	8pF	500V	CH	GRM42-2CH080D500PT	K22275211	TYP D	
C 6019	CHIP CAP.	9pF	500V	CH	GRM42-2CH090J500PT	K22275212	TYP E	3-
C 6019	CHIP CAP.	9pF	500V	CH	GRM42-2CH090J500PT	K22275212	TYP F	3-
C 6020	CHIP CAP.	10pF	50V	CH	GRM40CH100D50PT	K22170211	TYP A	5-
C 6020	CHIP CAP.	12pF	50V	CH	GRM40CH120J50PT	K22170213	TYP C	5-
C 6020	CHIP CAP.	10pF	50V	CH	GRM40CH100D50PT	K22170211	TYP D	
C 6020	CHIP CAP.	10pF	50V	CH	GRM40CH100D50PT	K22170211	TYP E	5-
C 6020	CHIP CAP.	10pF	50V	CH	GRM40CH100D50PT	K22170211	TYP F	5-
C 6021	CHIP CAP.	0.001uF	50V	B	GRM40B102M50PT	K22170805		
C 6022	AL. ELECTRO. CAP.	10uF	25V		ECEV1EV100SP	K48140003		
C 6023	CHIP CAP.	1pF	50V	CK	GRM40CK010C50PT	K22170202		
C 6024	CHIP CAP.	0.001uF	50V	B	GRM40B102M50PT	K22170805		
C 6025	CHIP CAP.	0.001uF	50V	B	GRM40B102M50PT	K22170805		
C 6026	CHIP CAP.	0.001uF	50V	B	GRM40B102M50PT	K22170805		
C 6027	CHIP CAP.	0.001uF	50V	B	GRM40B102M50PT	K22170805		

REF.	DESCRIPTION	VALUE	WV	TOL.	MFGR'S DESIG	YAESU P/N	VERS.	LOT.
C 6028	CHIP CAP.	0.001uF	50V	B	GRM40B102M50PT	K22170805		
C 6029	CHIP CAP.	0.001uF	50V	B	GRM40B102M50PT	K22170805		
C 6030	CHIP CAP.	0.001uF	50V	B	GRM40B102M50PT	K22170805		
C 6031	CHIP CAP.	0.001uF	50V	B	GRM40B102M50PT	K22170805		
C 6032	CHIP CAP.	0.001uF	50V	B	GRM40B102M50PT	K22170805		
C 6033	AL. ELECTRO. CAP.	10uF	25V		ECEV1EV100SP	K48140003		
C 6034	AL. ELECTRO. CAP.	47uF	25V		ECEV1EG470P	K48140004		
C 6035	CHIP CAP.	0.001uF	50V	B	GRM40B102M50PT	K22170805		
C 6036	CHIP CAP.	3pF	50V	CJ	GRM40CJ030C50PT	K22170204	TYP A	5-
C 6036	CHIP CAP.	3pF	50V	CJ	GRM40CJ030C50PT	K22170204	TYP C	5-
C 6036	CHIP CAP.	3pF	50V	CJ	GRM40CJ030C50PT	K22170204	TYP D	
C 6036	CHIP CAP.	3pF	50V	CJ	GRM40CJ030C50PT	K22170204	TYP E	5-
C 6036	CHIP CAP.	2pF	50V	CK	GRM40CK020C50PT	K22170203	TYP F	5-
C 6040	CHIP CAP.	0.001uF	50V	B	GRM40B102M50PT	K22170805		
C 6041	CHIP CAP.	0.001uF	50V	B	GRM40B102M50PT	K22170805		
C 6043	CHIP CAP.	100pF	50V	CH	GRM40CH101J50PT	K22170235		
C 6044	AL. ELECTRO. CAP.	47uF	25V		ECEV1EG470P	K48140004		
C 6045	CHIP CAP.	100pF	50V	CH	GRM40CH101J50PT	K22170235		
C 6047	CHIP CAP.	100pF	50V	CH	GRM40CH101J50PT	K22170235		
C 6048	CHIP CAP.	100pF	50V	CH	GRM40CH101J50PT	K22170235		
C 6049	CHIP CAP.	100pF	50V	CH	GRM40CH101J50PT	K22170235		
C 6050	CHIP CAP.	100pF	50V	CH	GRM40CH101J50PT	K22170235		
C 6051	CHIP CAP.	0.001uF	50V	B	GRM40B102M50PT	K22170805		
C 6052	CHIP CAP.	100pF	50V	CH	GRM40CH101J50PT	K22170235		
C 6053	TANTALUM CHIP CAP.	10uF	25V		TESVD1E106M12R	K78140018		
C 6054	CHIP CAP.	100pF	50V	CH	GRM40CH101J50PT	K22170235		
C 6055	CHIP CAP.	100pF	50V	CH	GRM40CH101J50PT	K22170235		
C 6056	CHIP CAP.	8pF	50V	CH	GRM40CHO80D50PT	K22170209	TYP A	5-
C 6056	CHIP CAP.	7pF	50V	CH	GRM40CHO70D50PT	K22170208	TYP C	5-
C 6056	CHIP CAP.	5pF	50V	CH	GRM40CHO50C50PT	K22170206	TYP D	
C 6056	CHIP CAP.	10pF	50V	CH	GRM40CH100D50PT	K22170211	TYP E	5-
C 6056	CHIP CAP.	10pF	50V	CH	GRM40CH100D50PT	K22170211	TYP F	5-
C 6057	CHIP CAP.	8pF	50V	CH	GRM40CHO80D50PT	K22170209	TYP A	5-
C 6057	CHIP CAP.	12pF	50V	CH	GRM40CH120J50PT	K22170213	TYP C	5-
C 6057	CHIP CAP.	8pF	50V	CH	GRM40CHO80D50PT	K22170209	TYP D	
C 6057	CHIP CAP.	10pF	50V	CH	GRM40CH100D50PT	K22170211	TYP E	5-
C 6057	CHIP CAP.	10pF	50V	CH	GRM40CH100D50PT	K22170211	TYP F	5-
C 6059	CHIP CAP.	3pF	50V	CJ	GRM40CJ030C50PT	K22170204	TYP D	
C 6060	CHIP CAP.	3pF	50V	CJ	GRM40CJ030C50PT	K22170204	TYP D	
D 6001	DIODE				1SS226 TE85R	G2070003		
D 6002	DIODE				1SS226 TE85R	G2070003		
D 6003	DIODE				1SS319 TE85R	G2070080		
D 6004	DIODE				1SS226 TE85R	G2070003		
J 6001					BNC-RM-1	P1090773A		
J 6002					BNC-LR	P1090254		
L 6004	CHIP COIL	0.01uH			LQN2A10NM	L1690001		
L 6005	CHIP COIL	0.018uH			LQN2A18NM	L1690004		
L 6006	COIL				8.5T4. ODO. 8UEW R	L0022203		
L 6008	COIL				1.5T5. OD1. 2UEW R	L0022271	TYP A	5-

PA UNIT

REF.	DESCRIPTION	VALUE	WV	TOL.	MFGR'S DESIG	YAESU P/N	VERS.	LOT.
L 6008	COIL				1.5T4.0D1.2UEW R	L0022270	TYP C	5-
L 6008	COIL				1.5T4.0D1.2UEW R	L0022270	TYP D	
L 6008	COIL				1.5T3.0D1.2UEW R	L0022272	TYP E	3-
L 6008	COIL				1.5T3.0D1.2UEW R	L0022272	TYP F	3-
L 6009	COIL				1.5T5.0D1.2UEW R	L0022271	TYP A	5-
L 6009	COIL				1.5T5.0D1.2UEW R	L0022271	TYP C	5-
L 6009	COIL				1.5T5.0D1.2UEW R	L0022271	TYP D	
L 6009	COIL				1.5T3.0D1.2UEW R	L0022272	TYP E	3-
L 6009	COIL				1.5T3.0D1.2UEW R	L0022272	TYP F	3-
L 6010	COIL				1.5T4.5D1.2UEW R	L0022277	TYP A	5-
L 6010	COIL				1.5T4.5D1.2UEW R	L0022277	TYP C	5-
L 6010	COIL				1.5T4.5D1.2UEW R	L0022277	TYP D	
L 6010	COIL				1.5T3.0D1.2UEW R	L0022272	TYP E	3-
L 6010	COIL				1.5T3.0D1.2UEW R	L0022272	TYP F	3-
L 6011	COIL				8.5T4.0D0.8UEW R	L0022203		
Q 6001	TRANSISTOR				2SC3357-T2	G3333577		
Q 6002	TRANSISTOR				MRF559	G3090070		
Q 6003	IC				M57729L	G1090753	TYP A	5-
Q 6003	IC				M57729	G1090622	TYP C	5-
Q 6003	IC				M57729H	G1090754	TYP D	
Q 6003	IC				M57729UH	G1090755	TYP E	3-
Q 6003	IC				M57729SH	G1090756	TYP F	3-
Q 6004	TRANSISTOR				2SB1132 T100 R	G3211327R		
Q 6005	TRANSISTOR				2SB1134R	G3211340R		
R 6001	CHIP RES.	470	1/10W	5%	RMC1/10T 471J	J24205471		
R 6002	CHIP RES.	12	1/10W	5%	RMC1/10T 120J	J24205120		
R 6003	CHIP RES.	470	1/10W	5%	RMC1/10T 471J	J24205471		
R 6004	CHIP RES.	1K	1/10W	5%	RMC1/10T 102J	J24205102		
R 6005	CHIP RES.	4.7K	1/10W	5%	RMC1/10T 472J	J24205472		
R 6006	CHIP RES.	47	1/10W	5%	RMC1/10T 470J	J24205470		
R 6007	CHIP RES.	100	1/10W	5%	RMC1/10T 101J	J24205101		
R 6008	CHIP RES.	4.7K	1/10W	5%	RMC1/10T 472J	J24205472		
R 6009	CHIP RES.	100	1/10W	5%	RMC1/10T 101J	J24205101		
R 6010	CHIP RES.	10	1/4W	5%	RMC1/4 100JATP	J24245100		
R 6011	CHIP RES.	1.2K	1/10W	5%	RMC1/10T 122J	J24205122		
R 6012	CHIP RES.	5.6K	1/10W	5%	RMC1/10T 562J	J24205562		
R 6013	CHIP RES.	4.7K	1/10W	5%	RMC1/10T 472J	J24205472		
R 6014	CHIP RES.	100K	1/10W	5%	RMC1/10T 104J	J24205104		
R 6019	CHIP RES.	0	1/4W	5%	RMC1/4 000JATP	J24245000		
R 6020	CHIP RES.	220	1/10W	5%	RMC1/10T 221J	J24205221		
R 6021	CHIP RES.	10	1/10W	5%	RMC1/10T 100J	J24205100		
TS6001	THERMAL SWITCH				OHD1-90M	Q9000611		